

SAM[®] SPLINT USER GUIDE



A pocket guide to the most
universal splint on the planet.

UPPER BODY & EXTREMITIES

LOWER EXTREMITIES

ALTERNATIVE USES

Written by Sam Scheinberg, M.D.

Published by

SAM Medical Products™

PO Box 3270

Tualatin, OR 97062

800.818.4726

Second Edition

Copyright 2012 SAM Medical Products™

All rights reserved.

No part of this book may be reproduced in any form, or by any electronic mechanical, or other means, without permission in writing from the publisher.

Printed in the USA.

SAM[®] **SPLINT** **USER GUIDE**

Written by Sam Scheinberg, M.D.

- The SAM[®] Splint is universal. It can be used to splint any part of the body.
- Lightweight (4 oz. for 4.25" × 36" splint).
- Waterproof.
- Easy to use.
- Radiolucent. You can x-ray through it.
- Foam padded for comfort.
- Easily rolled or folded for storage.
- Reusable. Easily cleaned and disinfected with normal cleaning solutions.
- Not affected by ambient temperature extremes or altitude. It even works underwater!
- Cuts easily with regular scissors.
- Fastens in place with tape or wrap. No extra equipment is required.
- Will not puncture.

As a trauma surgeon in Vietnam and later as the first orthopedic surgeon on the rugged Oregon Coast, Sam Scheinberg learned about the types of remote settings in which a splint might become necessary.

Sam found that the splints of the 1960s and 1970s were woefully inadequate. Bulky constructs of wire, cardboard, and all-too-easily punctured air chambers, they couldn't be reused, never seemed to

SAM[®] SPLINT HISTORY

fit and frequently caused more harm than good. Field medics often substituted even more old-fashioned techniques, such as lashing poles and branches (or even parts of a rifle) to the injured limb.

On his return to the U.S., Sam pondered this problem off and on for several years. Was there a way to make a lightweight, strong, reliable, reusable splint? After one 24-hour surgical shift, Sam was idly watching TV and chewing a stick of gum. He played with the foil gum wrapper, folding it into a band and rolling it around his little finger. He realized that, although flimsy in its normal state, the foil became much stronger when bent into a "U" shape. Could a splint be made from something similar?

The next day, Sam obtained a larger piece of aluminum and put the idea to work. A sheet of thin, soft aluminum becomes remarkably rigid when curved. With the right padding materials, Sam realized, it would make an exceptional splint.

Having satisfied his curiosity, Sam nearly let the project drop. But his wife Cherrie wouldn't let him. In what Sam later called "the luckiest ten minutes of nagging in my life," she hounded him until he agreed to bring the product to the world.



Dr. Scheinberg

After years of meticulous experimentation, in 1985 Sam and Cherrie were selling the first SAM[®] Splint. Today, the SAM Splint is the most popular emergency splint in the world, favored not only by emergency crews, but also by armed services, athletic trainers and outdoor adventurers. To quote *Outward Bound's Wilderness First-Aid Handbook*, "It is the only splint worth carrying on your back."

The SAM Splint is a product that has come to reflect SAM Medical Product's philosophy in all of its endeavors. If you're going to make something, don't just make it good; make it better than anything else currently available. Make it so much better that, like the SAM Splint, it sets a new "gold standard" in its field.

CONTENTS

Introduction	7
Basic Information & General Information	8
The Concept: The Basic Bend	12
Advanced Bends	13
■ Upper Body & Extremities.....	14
Finger Splint.....	14
Volar Wrist	15
Thumb Spica.....	17
Ulnar Gutter	19
Double Layer Wrist.....	20
Humeral Shaft (Upper Arm).....	22
Sugar Tong.....	24
Dislocated Elbow	26
Adjustable Cervical Collar.....	28
Anterior Dislocation of the Shoulder	31

CONTENTS

■	Lower Extremities	32
	Ankle Stirrup	32
	Figure Eight	34
	Combo Ankle Stirrup & Figure Eight	36
	Single Long Leg.....	38
	Double Long Leg	40
	Knee Immobilizer.....	42
■	Alternative Uses	44
■	Other SAM Medical Products	52

INTRODUCTION

This manual begins with a discussion of the general properties of the splint. This section contains information regarding construction, principles of use, environmental comments, cutting, cleaning, and precautions.

The techniques described are not intended to be all-inclusive but should contain the most commonly used SAM® Splint configurations. At the urging of my wilderness medicine comrades, I have included a chapter on alternative uses. A special thanks is extended to my energetic wife Cherrie, whose encouragement produced this book, and to our volunteer and professional emergency medical personnel friends around the world for their support, ideas and ingenuity.

BASIC INSTRUCTIONS & GENERAL INFORMATION

Acclaimed by emergency care providers and outdoor enthusiasts worldwide (and even beyond the Earth, on NASA space shuttles), the SAM Splint is based on an ancient construction principle: curves are strong.

Old-style splints derive their strength from the materials from which they are constructed: metal, wood, plaster, etc. To be strong, they have to be heavy, bulky, and not easily adjustable. The SAM Splint is built from a thin core of soft aluminum alloy sandwiched between two layers of closed-cell foam. Fresh out of the package, the splint is extremely pliable. Bent into a simple curve, it becomes extremely strong and supportive for any fractured or injured limb.

It follows the mechanics of curved surfaces—the same physics that allows skyscrapers and bridges to be built of I-beams and hollow columns rather than heavy steel pillars. A flat piece of sheet metal bends easily, but if you mold it into any of several “structural curves” it becomes much more rigid. With these, you can convert a simple SAM Splint into something so strong that people have even used it as an emergency canoe paddle or snow shovel. At the same time, the SAM Splint is extremely moldable, and soft enough to cut with ordinary household scissors. The result: almost any bone in the body can be splinted. It’s even possible to use the SAM Splint to create an emergency cervical collar for neck injuries.

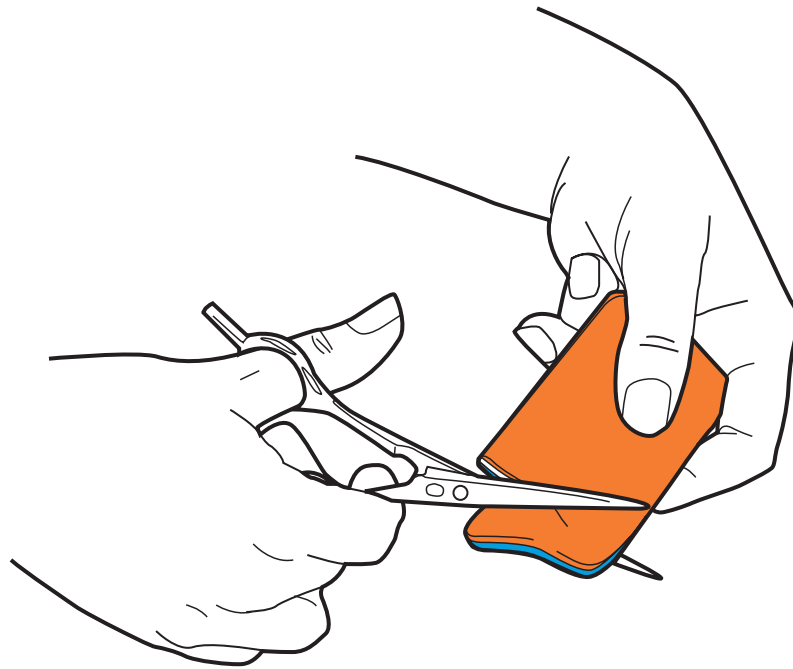

The SAM Splint is radiolucent, almost invisible on x-ray. It should NOT be removed for radiographs (x-rays). It is designed to function through the extreme ranges of normal ambient temperatures. It is waterproof, but not fireproof. The closed pore EVA foam will not flash when exposed to flame, but will begin to melt and eventually ignite after approximately 8 seconds. The SAM Splint is easily cut with ordinary scissors. Cutting exposes the thin aluminum core. Unless serrated scissors have been used, the aluminum is usually not very sharp. To prevent any injury from the exposed edge, we recommend folding the edge on itself 1 to 2 times. Covering the edge with tape is also effective.

The foam used in the SAM Splint was selected for its “cleanability”. Whether cut or used intact, the splint can be cleaned with antiseptic soap and water or with almost any protocol cleaning solution. We suggest an inexpensive 1:9 mixture of commercially available bleach and water. The closed pore polyurethane foam which promotes effective cleaning does not, however, absorb or allow passage of air or perspiration. This does not present a problem during short-term use.



If, however, the splint is to be maintained for prolonged periods (hours to days), some absorbent material such as cotton cloth, cast padding, or double tubular stockinette should be placed between the splint and patient to prevent skin maceration and odor.

Although the foam does provide some padding, an additional soft pad should be placed around all bony prominences to prevent pressure points when prolonged use is contemplated.

Technical Details

The core of the SAM Splint is a long rectangle of ultra-thin aluminum alloy. The covering layers are made of dermatologically safe foam. The SAM Splint is 4.25" wide and comes in pre-packaged lengths of 36 inches, 18 inches and 9 inches for splinting everything from a child's arm to a basketball player's leg. They are also available as a finger splint which measures 3.75" × 1.75", and in an XL size with a width of 5.5".

Safety Tips

If prolonged use is anticipated (more than a few hours), place absorbent material, such as cotton cloth, between the splint and the skin to prevent skin irritation and odor. Also, to prevent uncomfortable pressure points during prolonged use, place soft padding (such as gauze pads) around all bony prominences. When cutting the splint, avoid using serrated scissors as they may produce sharp edges. After cutting, roll the cut end over or apply tape to cover any exposed metal.

CAUTION: The splint is non-sterile. To reuse the SAM Splint, wash thoroughly with disinfectant before repacking.



THE CONCEPT: THE BASIC BEND

A SAM Splint in its virgin state (without any bends) is completely malleable. When a curve or fold is placed anywhere across its longitudinal axis, it becomes rigid and suitable for splinting almost any bone on the body. Always use curves to add strength and rigidity to the SAM Splint. **The basic C-Curve meets most splinting needs.**

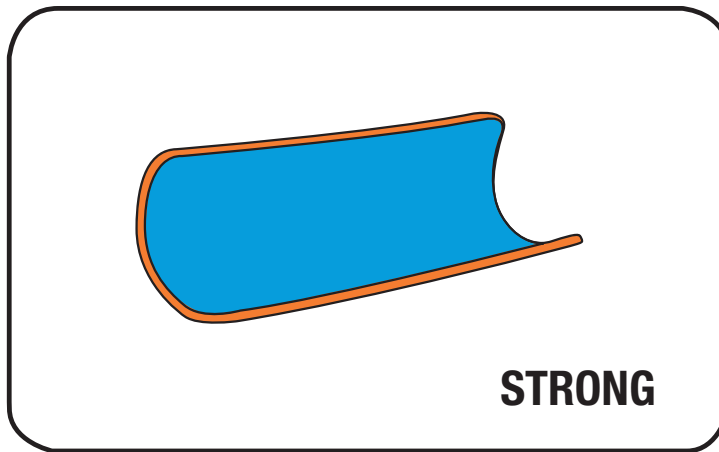

The C-Curve

To create the *C-Curve*, place both thumbs in the center of the SAM Splint. Using your thumbs as a brace, pull the edges of the splint toward you to create a shallow *C-Curve*. This curve immediately adds strength and rigidity to the splint. For greater strength, deepen the bend.

ADVANCED BENDS

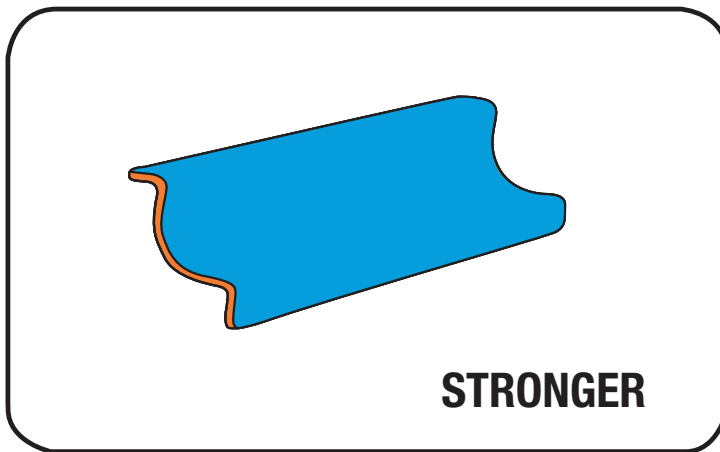

The Reverse C-Curve

First, form a *C-Curve*. Then add additional strength by bending the edges of the C-Curved splint back in the reverse direction.

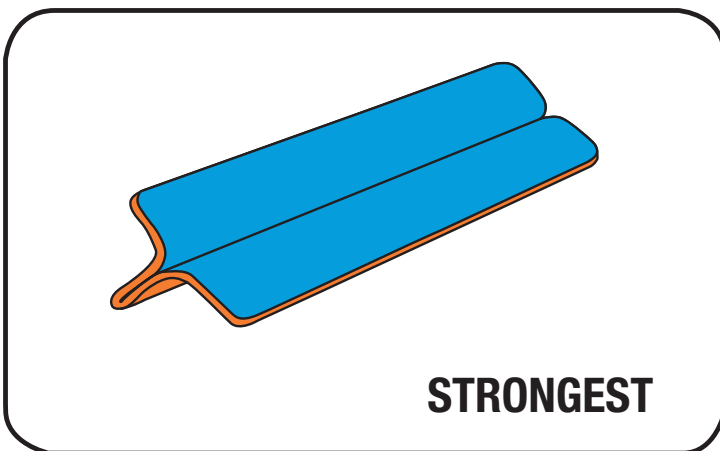

The T-Curve

This bend adds exceptional strength to the splint. To create the *T-Curve*, fold the outer edges of the splint together. Next, bend half of each side of the fold in the opposite direction to create a “T” shaped beam.

FINGER SPLINT

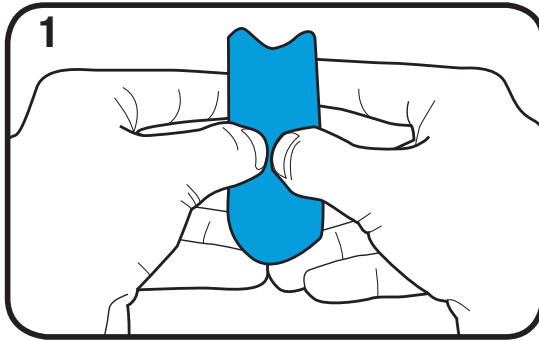

Step 1: To create a simple finger splint or fingertip guard, first form a SAM Finger Splint into the *C-Curve*.

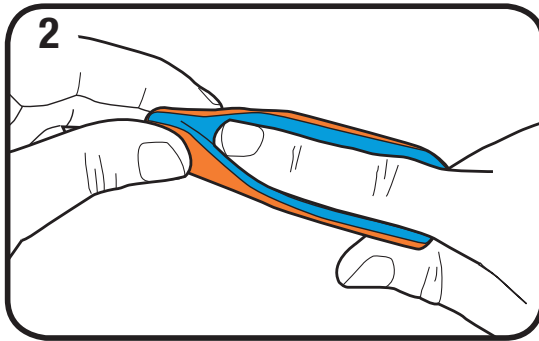

Step 2: Place the finger in the curved surface of the splint. Squeeze the end of the splint to create a fingertip guard.

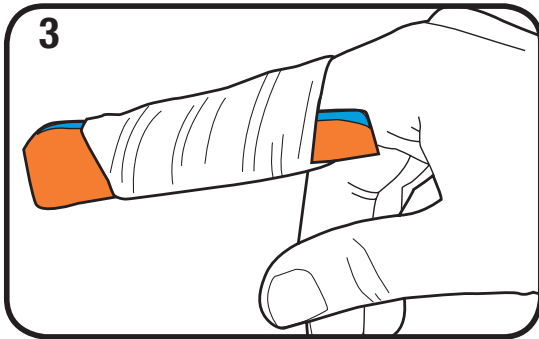

Step 3: Secure with your wrap of choice.

Applications

- Fingertip injuries
- Finger fractures
- Finger lacerations

VOLAR WRIST

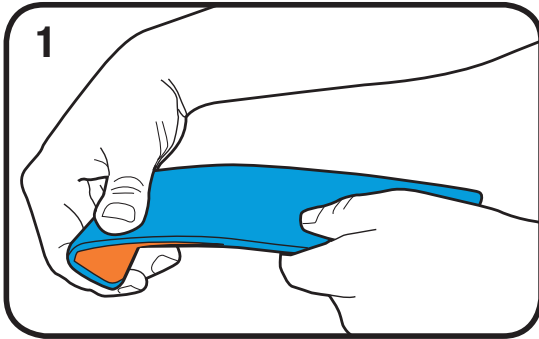

Step 1: Roll the end of a 9-inch (for children) or 18-inch (for adults) SAM Splint over to provide comfort for fingers.

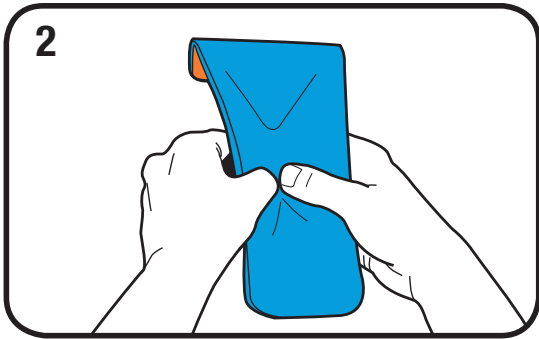

Step 2: Apply a *C-Curve*.

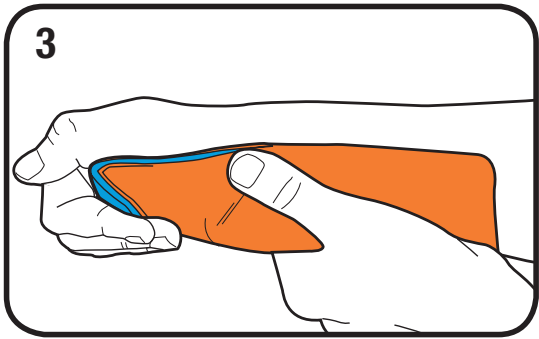

Step 3: Using your own right or left hand and wrist as a template, mold the splint into the position of function.

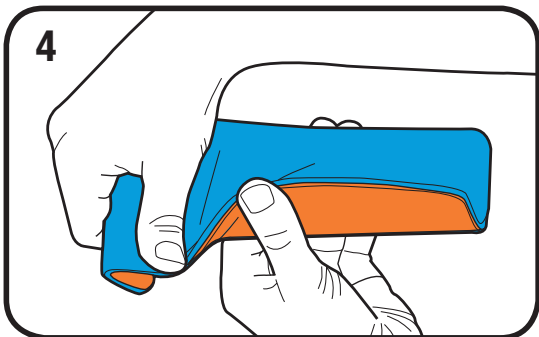

Step 4: Be sure to create a generous curve for the base of the thumb.

VOLAR WRIST (CONTINUED)

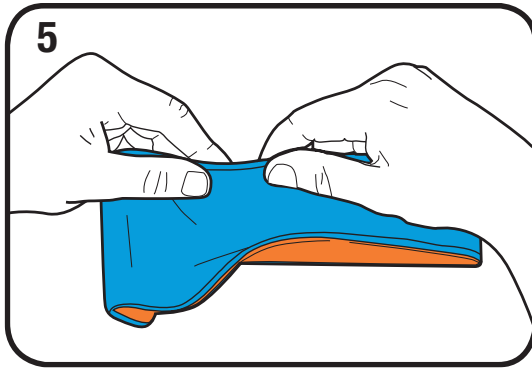

Step 5: Obtain additional strength by folding up the ulnar (little finger) side of the splint.

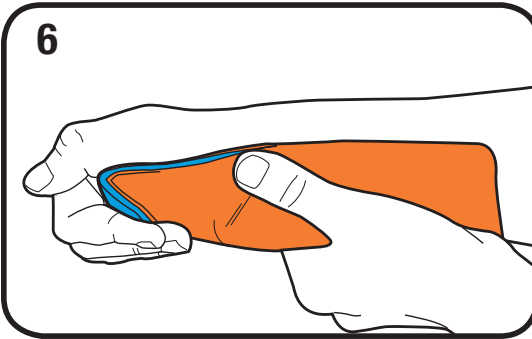

Step 6: Apply to patient.

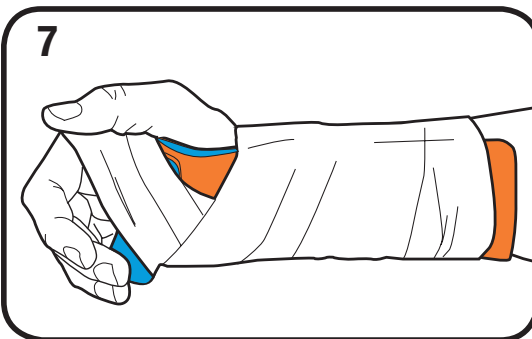

Step 7: Make fine adjustments as necessary. Secure with your wrap of choice.

Applications

- Wrist fractures/pains
- Lacerations
- Carpal Tunnel Syndrome
- Night splints

THUMB SPICA

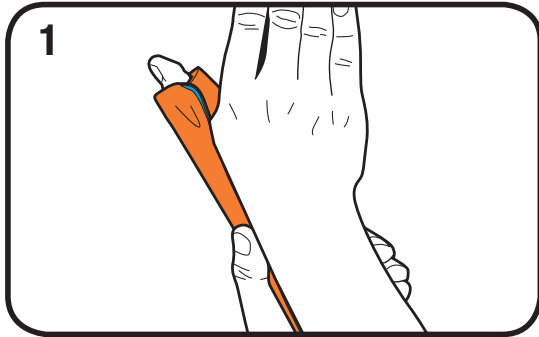

Step 1: Using your own right or left thumb and wrist as a template, mold the thumb spica shape into the selected SAM Splint. A 9-inch splint works well for this.

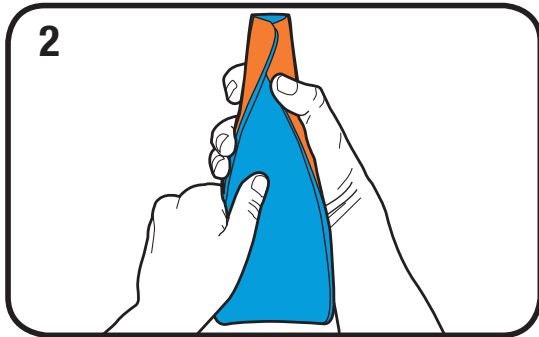

Step 2: Be sure to create a generous curve for the base of the thumb.

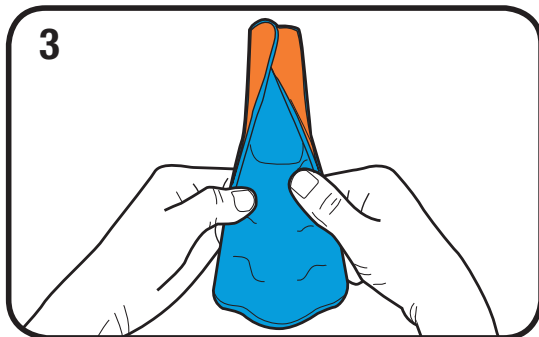

Step 3: You may add *Reverse C-Curves* on the edges as needed for additional strength if desired.

THUMB SPICA (CONTINUED)

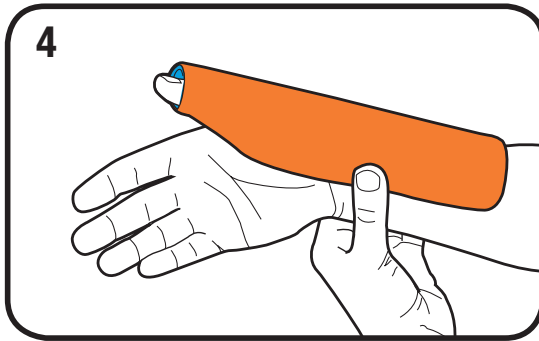

Step 4: Apply to the patient. Make fine adjustments as necessary.

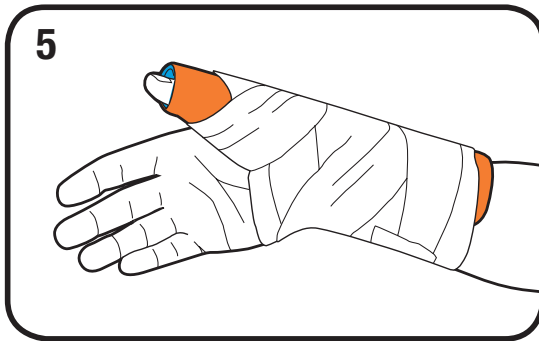

Step 5: Secure with your wrap of choice.

Applications

- Navicular/scaphoid fractures
- Thumb dislocations or fractures
- Ulnar collateral ligament sprains
- Tendonitis

ULNAR GUTTER

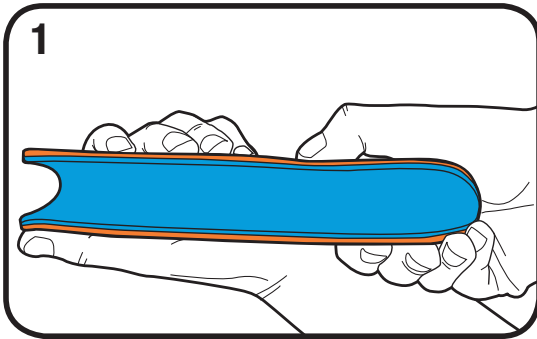

Step 1: Fold a 9-inch SAM Splint length-wise.

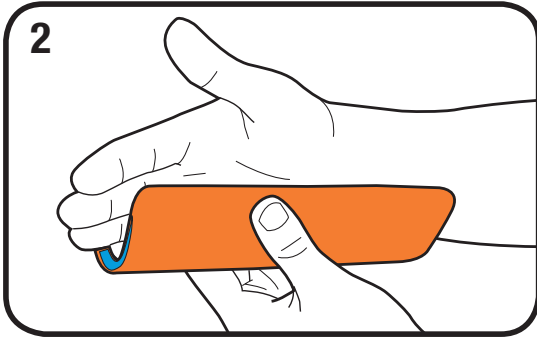

Step 2: Using the ulnar side of your own hand and wrist as a template, mold the splint into the desired shape.

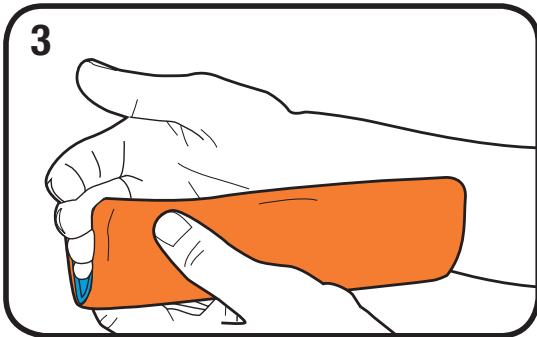

Step 3: Apply to the patient.

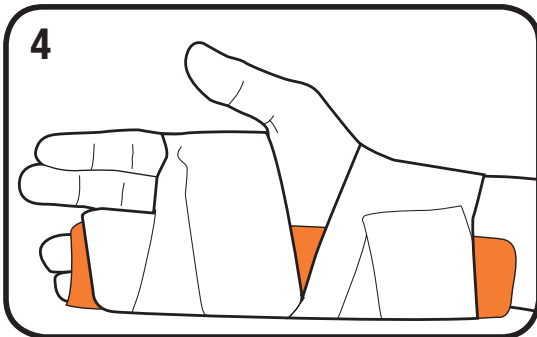

Step 4: Make fine adjustments as needed and secure with your wrap of choice.

Applications

- Fifth metacarpel fractures
- Little finger injuries
- Ring finger injuries

DOUBLE LAYER WRIST

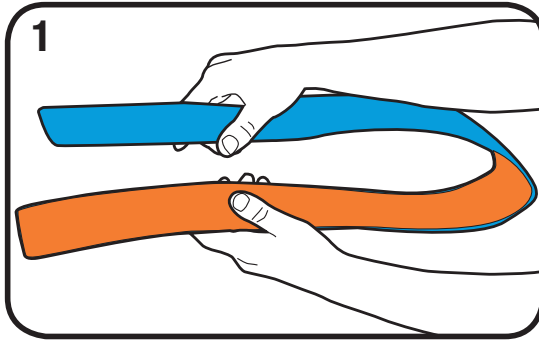

Step 1: Fold a 36-inch SAM Splint in half upon itself.

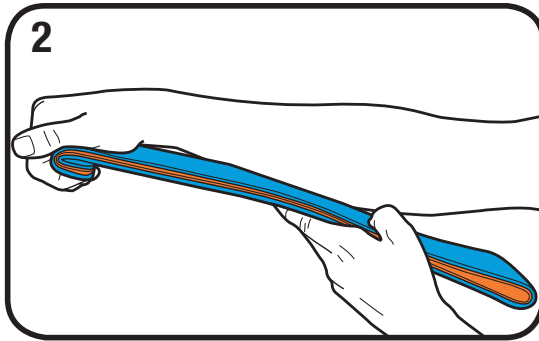

Step 2: Roll the end over to provide more comfort for the fingers.

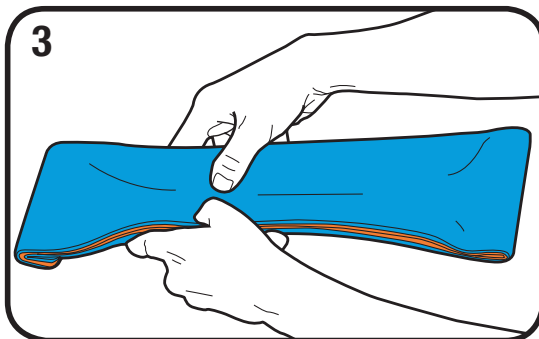

Step 3: Add strength by creating a *C-Curve*.

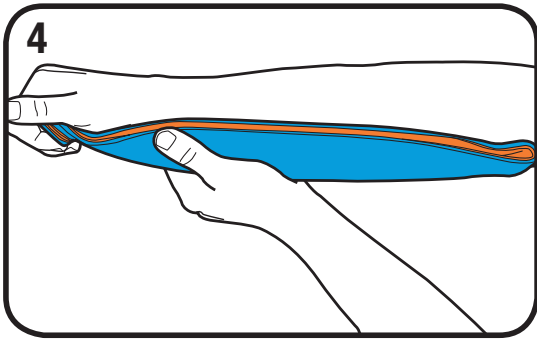

Step 4: Using your own right or left arm as a template, mold the splint to the general shape of the wrist and forearm.

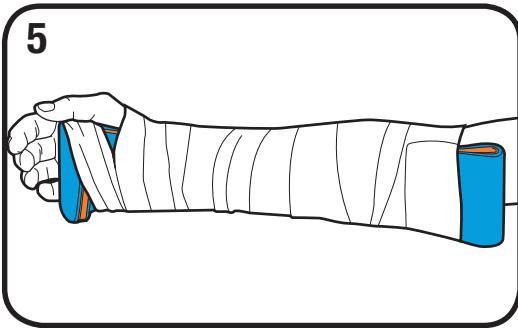

Step 5: Make adjustments to fit the injury and apply to the patient. Only small adjustments should be made once the splint is in place. Secure with your wrap of choice.

Applications

- Wrist fractures or sprains
- Tendonitis
- Lacerations

HUMERAL SHAFT (UPPER ARM)

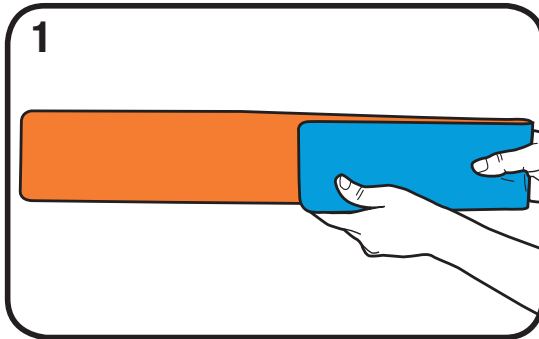

Step 1: Fold one third of a 36-inch SAM Splint upon itself to create a 12-inch section of double-layered splint.

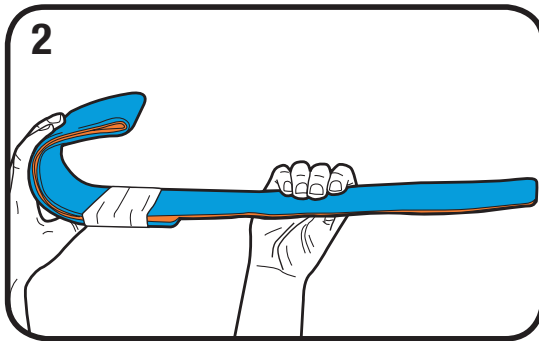

Step 2: Curve the double layer into a fishhook shape and secure the double layer with your wrap of choice.

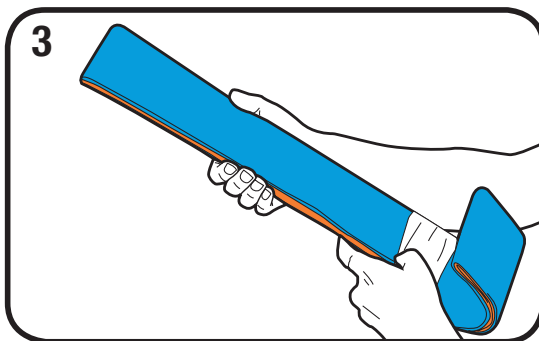

Step 3: Form a *C-Curve* along the shank of the fishhook for strength and fit.

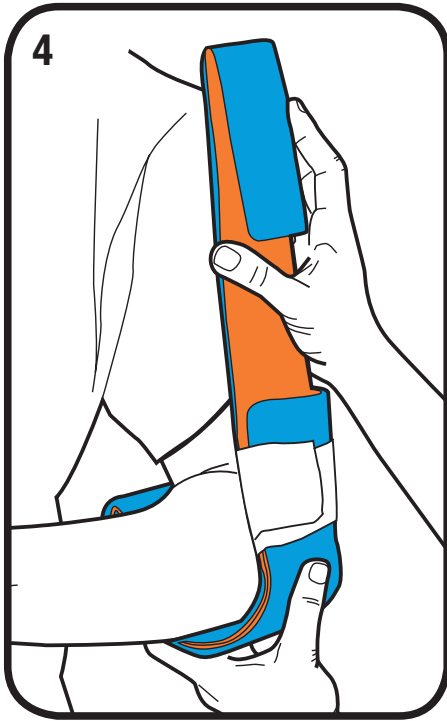

Step 4: Apply the splint to the patient. Fold any excess splint over the patient's shoulder or back upon itself.

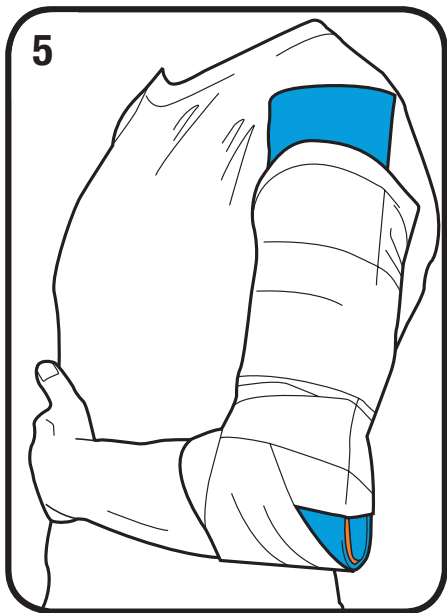

Step 5: Secure with your wrap of choice. Apply a sling and swath for additional support.

Applications

- Humeral shaft fractures

SUGAR TONG

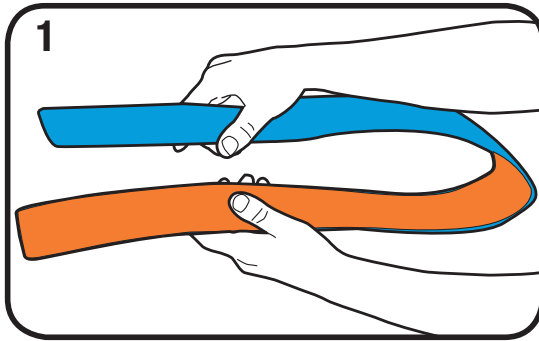

Step 1: Fold a 36-inch SAM Splint in half.

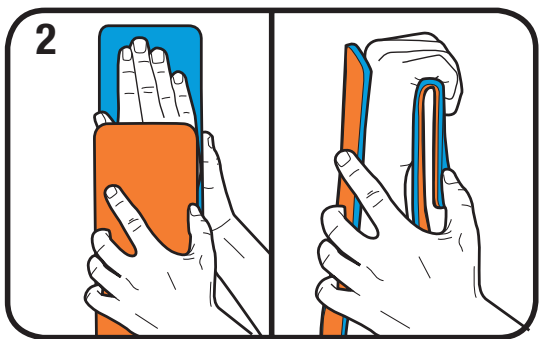

Step 2: To obtain the correct length use the patient's arm as a template. Place the folded splint around the elbow so the end of the top half stops at the knuckles. Fold the bottom half down even with the top.

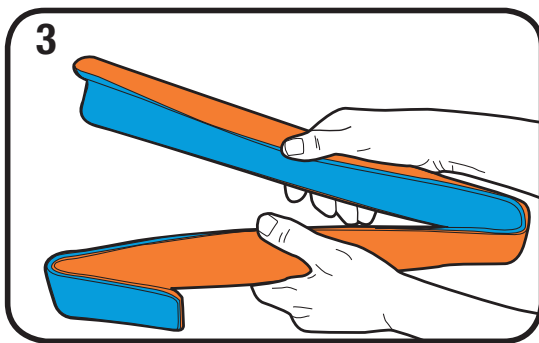

Step 3: Form a *C-Curve* in each half. Extend the *C-Curve* no further than two-thirds the distance down each half. If you extend the curve farther, it will limit your ability to fold the splint around the elbow.

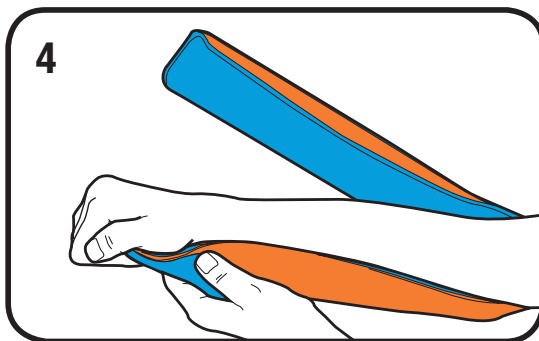

Step 4: Using your own right or left arm as a template, shape the splint to fit.

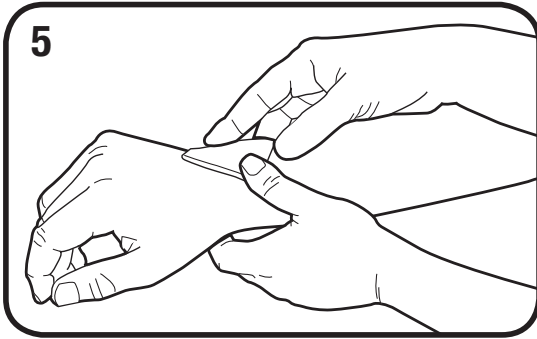

Step 5: Pad any bony prominences about the wrist and elbow.

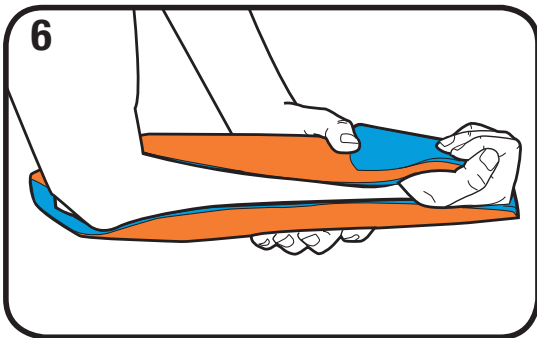

Step 6: Fit the splint to the patient.

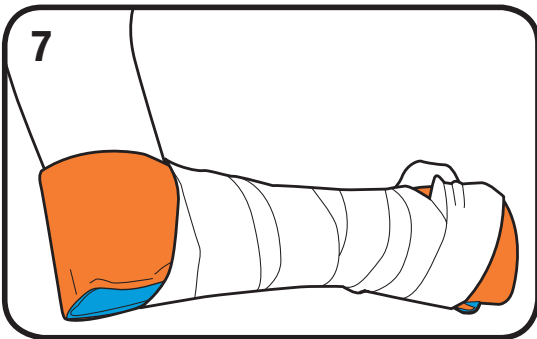

Step 7: Secure splint with your wrap of choice.

Applications

- Dislocated elbow
- Maintaining elbow extension

DISLOCATED ELBOW

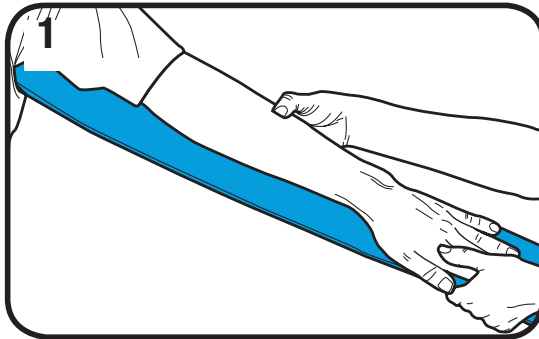

Step 1: Using the patient's non-affected arm, extend a 36-inch SAM Splint from just below the patient's armpit to the knuckles.

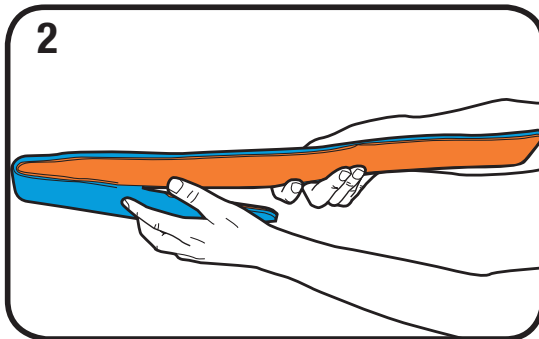

Step 2: Fold over any portion of the splint that extends beyond the knuckles.

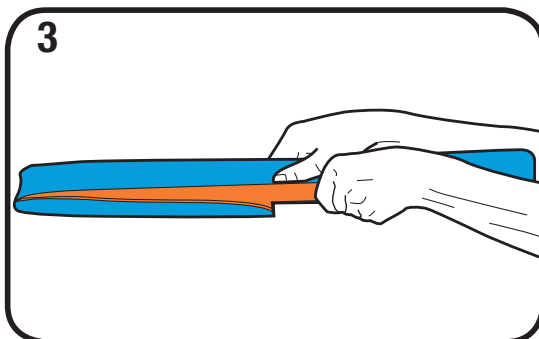

Step 3: Form a *C-Curve* down the entire length of the splint.

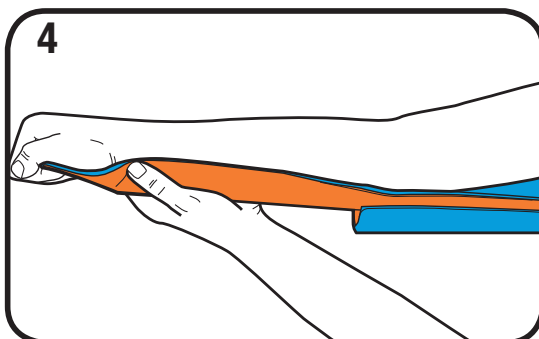

Step 4: Using your own right or left arm as a template, shape the splint to fit.

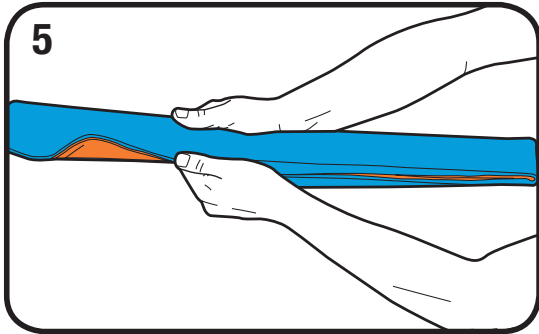

Step 5: You may create *Reverse C-Curve* bends on the edges as needed for strength.

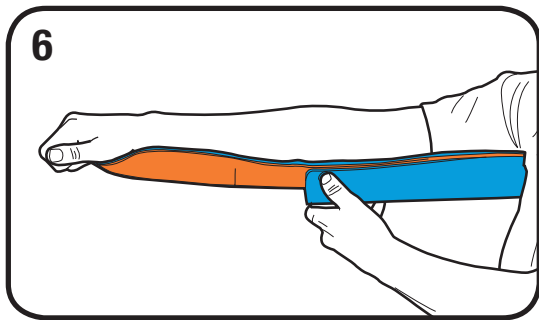

Step 6: Apply the splint to the patient.

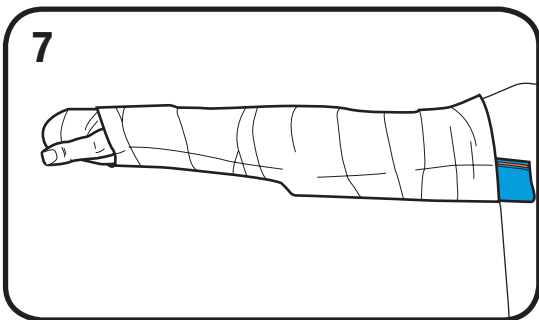

Step 7: Secure with your wrap of choice.

Applications

- Dislocated elbow
- Maintaining elbow extensions

ADJUSTABLE CERVICAL COLLAR

If no pre-formed cervical collar is available, a 36-inch SAM Splint can be used to form an Adjustable Cervical Collar.

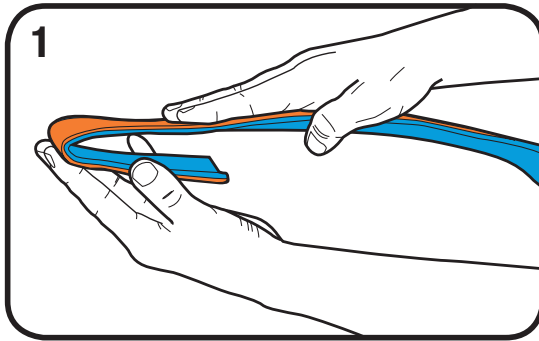

Step 1: Fold a 36-inch SAM Splint five inches from the end.

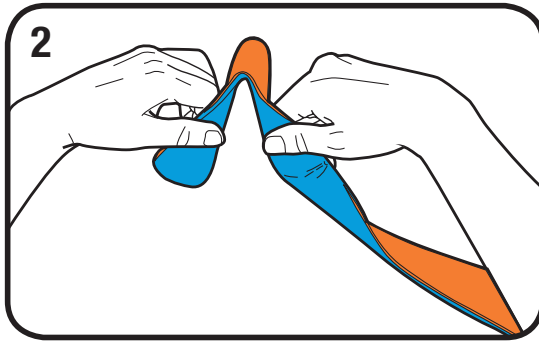

Step 2: Bracing your thumbs on each side of the fold, pull the upper edges toward you to create a “V” shaped chin rest.

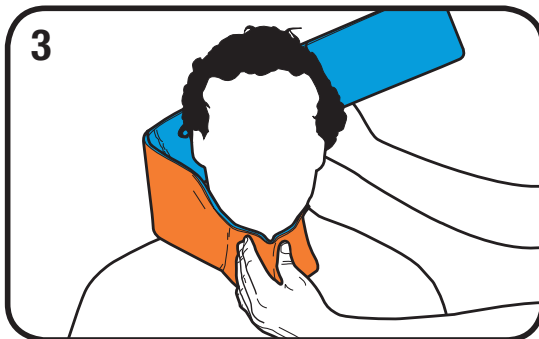

Step 3: Place the chin rest beneath the patient’s chin and lower jaw. Be careful to avoid pressure on the front of the neck. Loop the remaining portion of the splint loosely around the neck.



Step 4: Bring the end forward and down in an oblique direction until it touches the chest. This creates the correct chin-to-chest distance for the chin post.



Step 5: While continuing to support the chin, bring the chest portion of the splint around the original chin rest to create a chin-post. Squeeze to deepen the chin-post.



Step 6: Insert your index fingers in each side of the looped splint. Pull outward.

ADJUSTABLE CERVICAL COLLAR

(CONTINUED)



Step 7: Squeeze to create two side or lateral posts and ensure a snug fit.



Step 8: If the patient is sitting, you can form a back or posterior post in a similar manner.



Step 9: Fold up any excess splint. Secure with tape or your wrap of choice.

Applications

- Suspected neck injuries

ANTERIOR DISLOCATION OF THE SHOULDER

In this common dislocation, the patient's arm is typically most comfortable when supported in the abducted (sitting away from the body) position. The arm can be supported in this manner with a rolled ski parka, blanket, pillow or SAM Splint "triangle". To create a "triangle" your splint is first folded into thirds. This produces three equal 12" sections of splint.

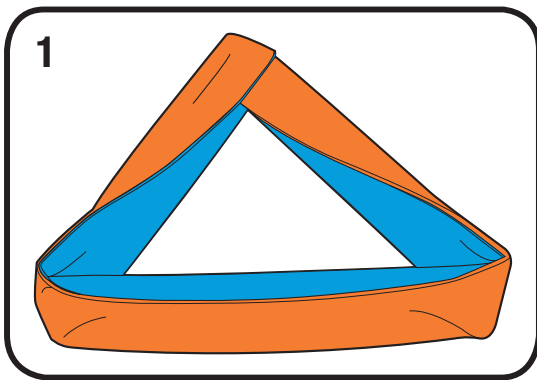

Step 1: Fold the outer sections along the longitudinal axis, leaving the middle section flat. Hook the outer folded ends together, producing a triangle.

A more rounded, gentler curve or half-circle is then folded along the longitudinal axis of the flat section of the triangle. This curve is formed to contour to the shape of the arm.

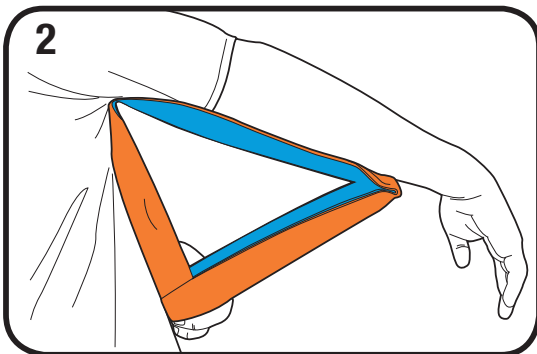

Step 2: The triangle is then placed in the axilla and used to support the abducted arm. The arm triangle is held in place by the patient or secured to the patient's trunk with your wrap of choice.

Applications

- Shoulder dislocation

ANKLE STIRRUP

If a patient has to walk in rough terrain on the injured limb, you may choose to leave footwear in place.

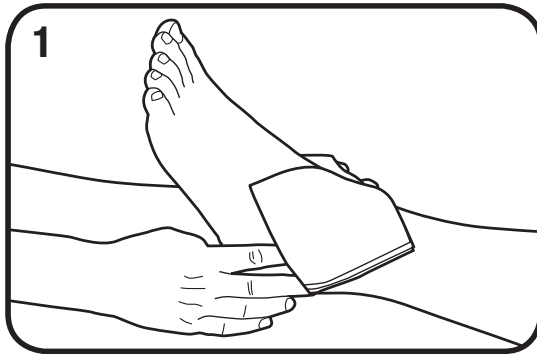

Step 1: If footwear is removed or when the ankle is exposed, place padding above and around the bony prominences on each side of the ankle.

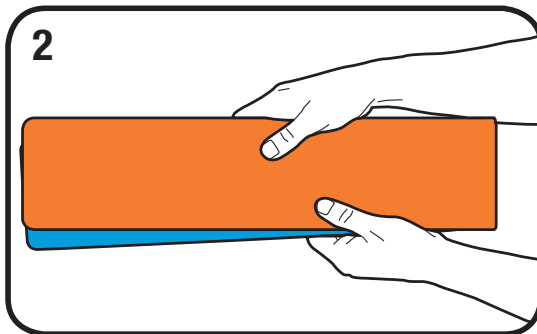

Step 2: Fold a 36-inch SAM Splint to create two equal halves.

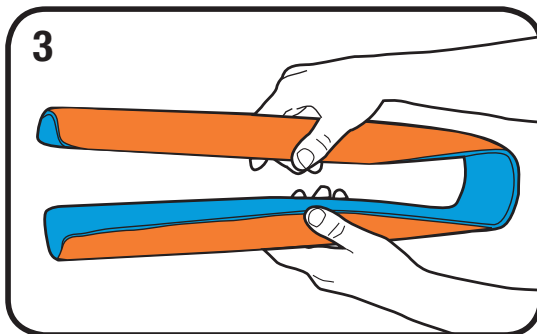

Step 3: Apply *C-Curves* two-thirds of the distance down each half. Add *Reverse C-Curves* on the edges if needed for strength. Do not extend the curves further or they will stiffen the splint and limit your ability to fold it around the foot and ankle.

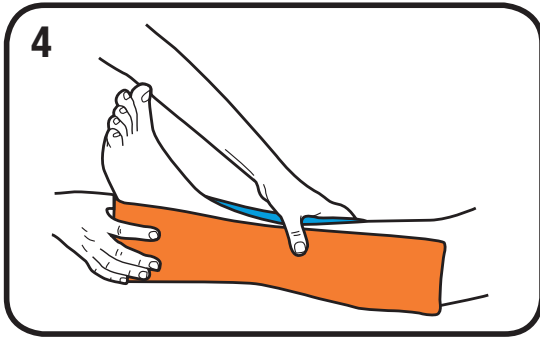

Step 4: Fold the stirrup splint around the foot and ankle.

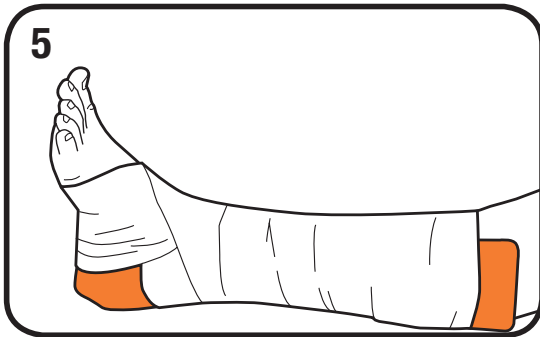

Step 5: Secure with your wrap of choice.

Applications

- Ankle fractures and sprains
- Lower leg fractures

FIGURE EIGHT

If a patient has to walk in rough terrain on the injured limb, you may choose to leave footwear in place.

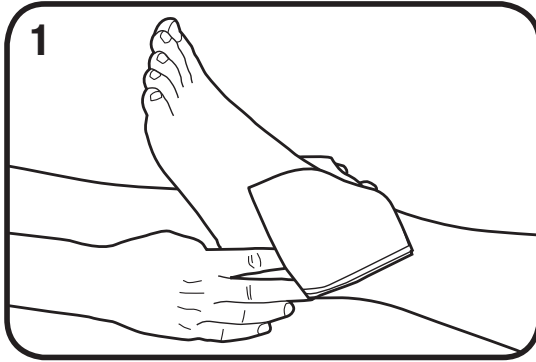

Step 1: If footwear is removed or when the ankle is exposed, place padding above and around the bony prominences on each side of the ankle.

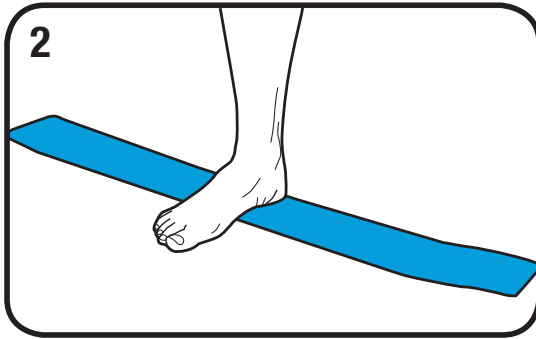

Step 2: Lay a 36-inch SAM Splint flat. Place the patient's foot in the middle of the splint so that the splint lies just forward of the heel.

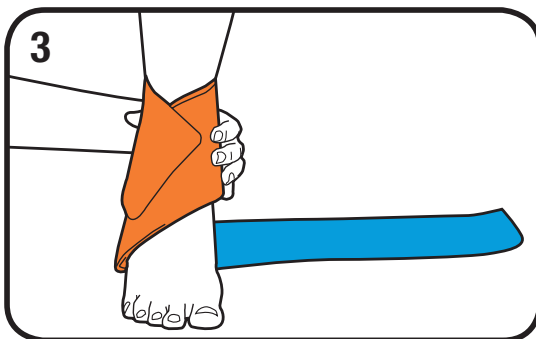

Step 3: Conform one half of the splint snugly around the ankle.

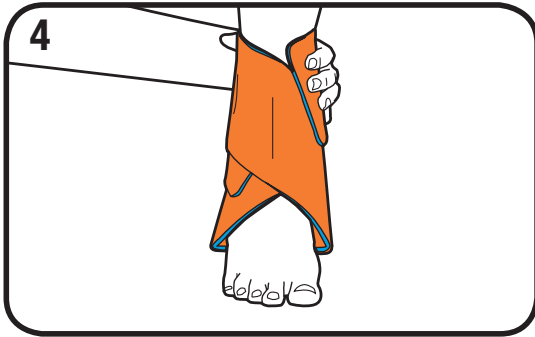

Step 4: Fold the second half of the splint around the first in a Figure Eight position. Crimp as necessary to fit.



Step 5: Secure with your wrap of choice.

Applications

- Ankle fractures and sprains

COMBO ANKLE STIRRUP & FIGURE EIGHT

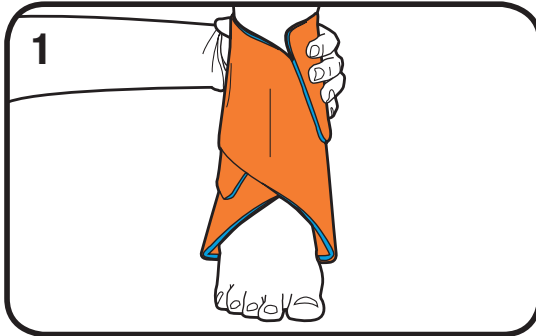

Step 1: First apply a *Figure Eight Splint*, as shown in the previous section of this training manual.

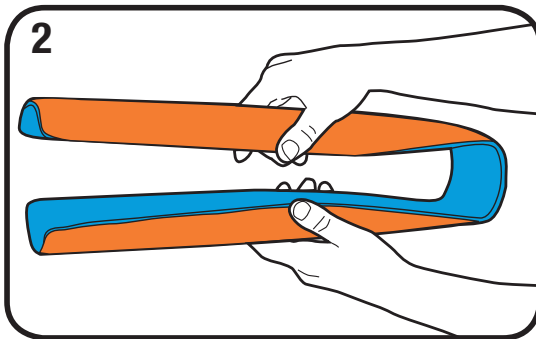

Step 2: Next, prepare an *Ankle Stirrup Splint* as shown in previous section of this training manual.

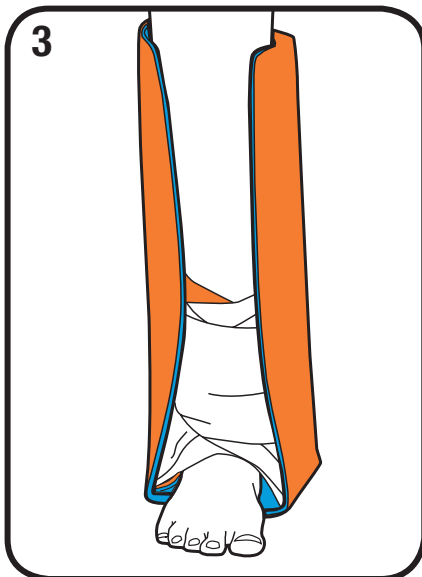

Step 3: Apply the Ankle Stirrup Splint over the *Figure Eight Splint*.

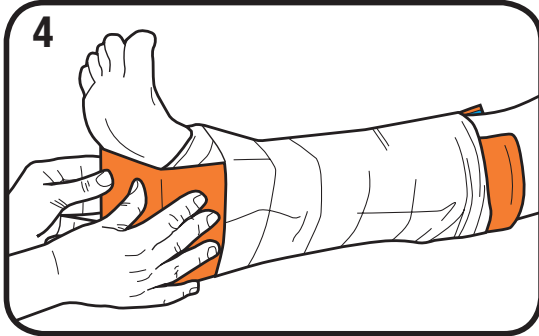

Step 4: Secure with your wrap of choice and crimp as needed to fit.

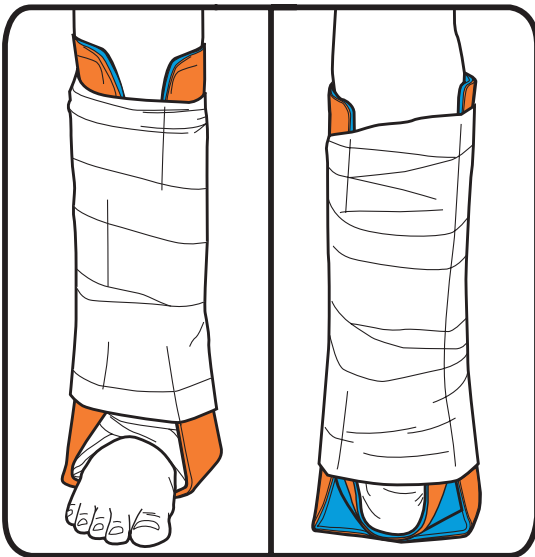

Front

Back

Applications

- Ankle fractures and sprains where greater immobilization is needed

SINGLE LONG LEG

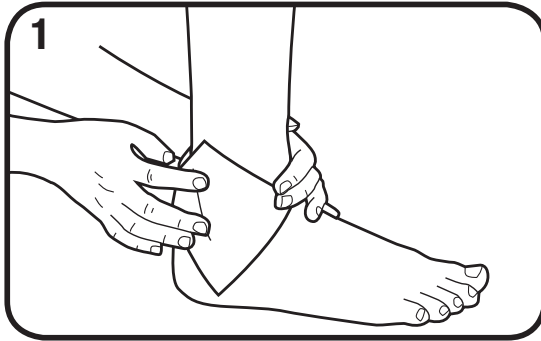

Step 1: If footwear is removed or when the ankle is exposed, place padding above and around the bony prominences on each side of the ankle.

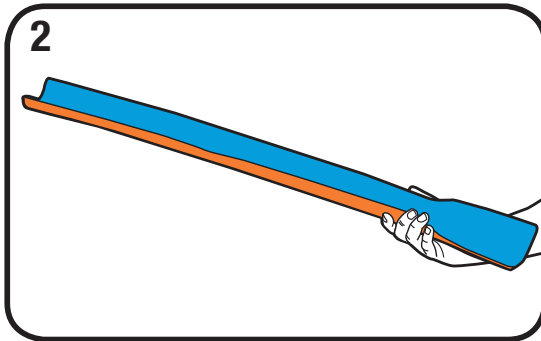

Step 2: Apply a *C-Curve* to approximately 30 inches of a 36-inch SAM Splint. Leave the last 6 inches of the splint flat and soft to fold under the foot.

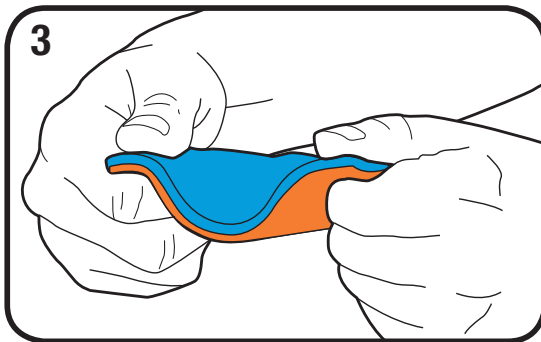

Step 3: For extra strength, apply *Reverse C-Curves* on the edges where necessary.

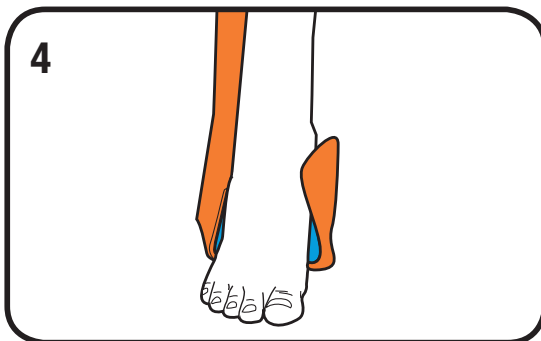

Step 4: Place the splint against the outside of the leg and fold the soft portion of the splint under the foot to create a foot-plate.



Step 5: Adjust splint to fit the leg.

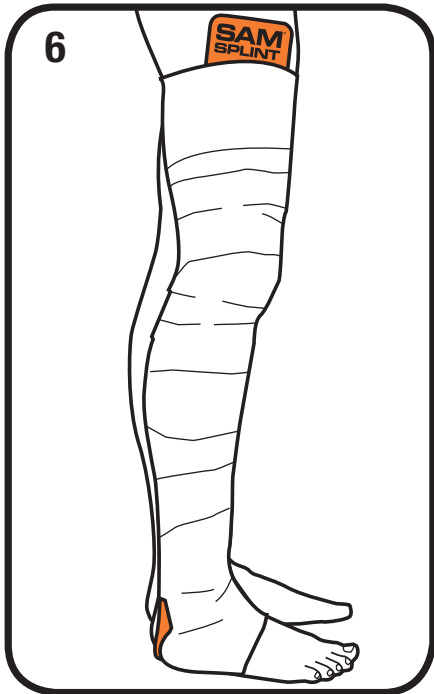

Step 6: Secure with your wrap of choice.

Applications

- Leg fractures (tibia or fibula)

DOUBLE LONG LEG

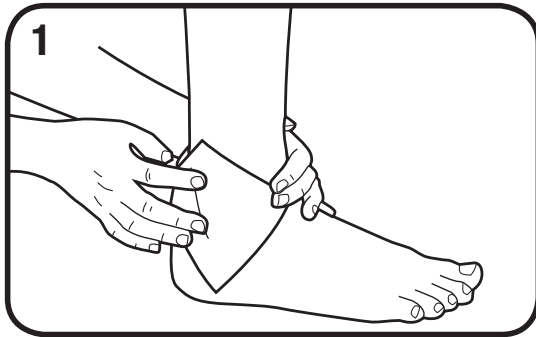

Step 1: If footwear is removed or when the ankle is exposed, place padding above and around the bony prominences on each side of the ankle.

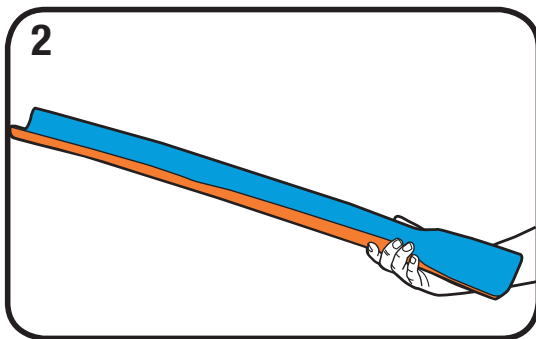

Step 2: Create a long leg splint as shown in the *Single Long Leg* segment of this manual.

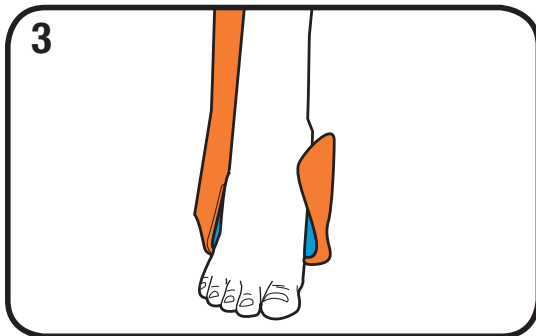

Step 3: Apply the long leg splint to the outer aspect of the leg.

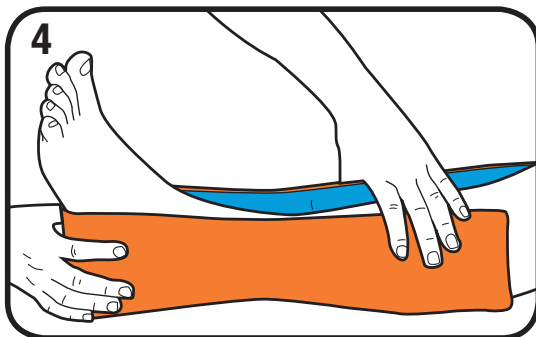

Step 4: Prepare a second splint, identical to the first. Apply this splint to the inner aspect of the leg.

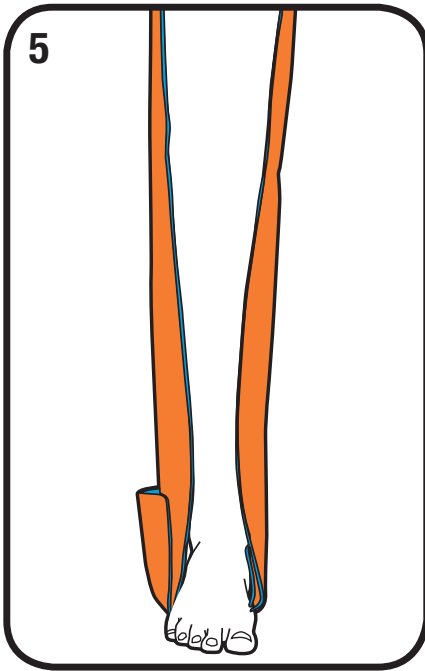

Step 5: Fold the soft, flat end over the first footplate.

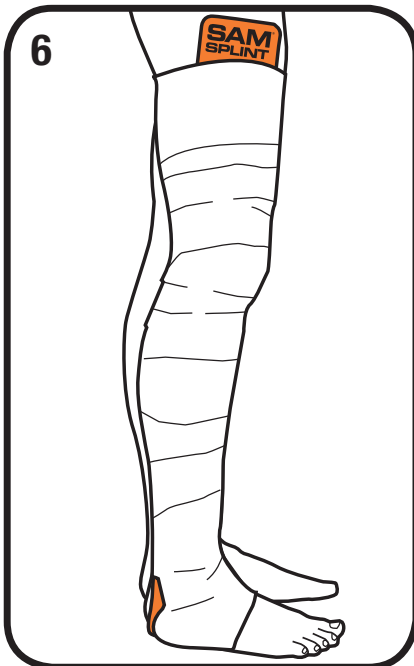

Step 6: Secure both splints to leg with your wrap of choice.

Applications

- Leg fractures (tibia or fibula) where greater immobilization is needed

KNEE IMMOBILIZER

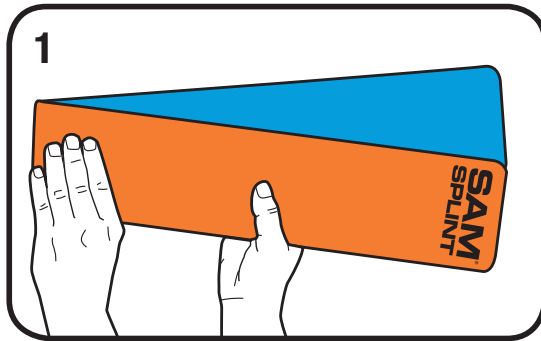

Step 1: Fold a 36-inch SAM Splint in the center to create 2 equal halves. Spread the two halves to produce a fan-shaped splint, wider at the top for the thigh and narrower at the bottom for the calf.

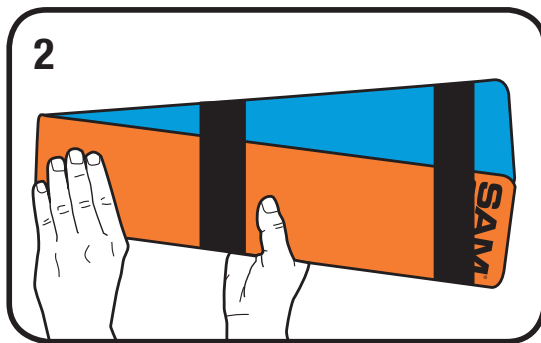

Step 2: Apply tape to the top and middle portions of the splint to maintain the fan shape.



Step 3: Create a second fan shaped splint.

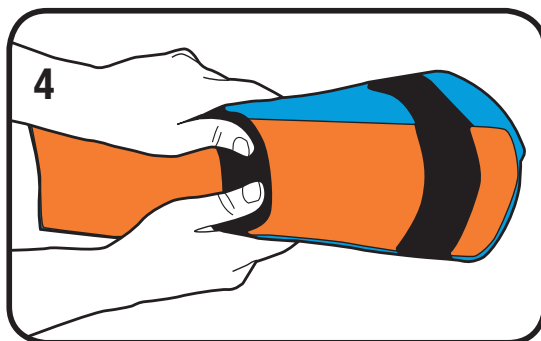

Step 4: Form a *C-Curve* in each SAM Splint.

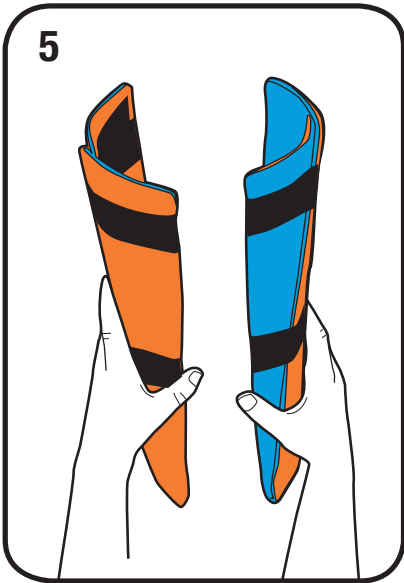

Step 5: The *C-Curves* should appear as above.

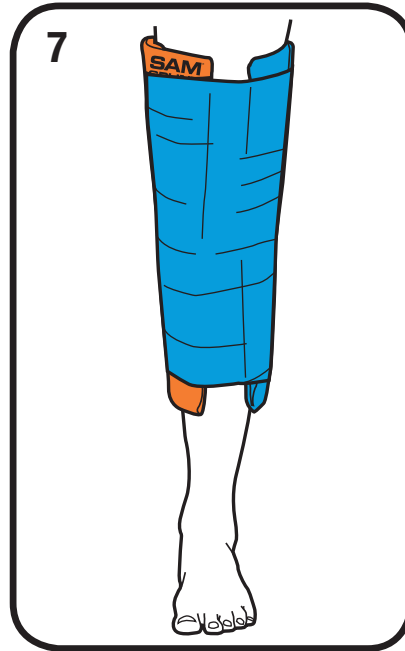

Step 7: Secure with your wrap of choice.

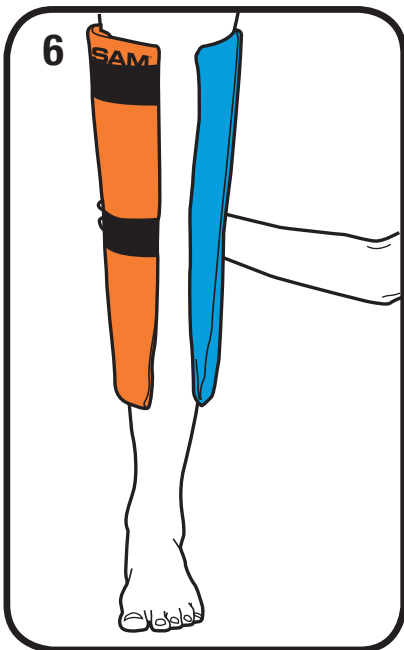

Step 6: Place one splint on each side of the knee and make fine adjustments to fit.

Applications

- Knee injuries
- Sprains
- Strains

ALTERNATIVE USES

Military Personnel, Athletic Trainers, Paramedics and Outdoor Adventurers are among the core group of enthusiasts who first recognized the versatility of the SAM Splint. Often working with limited resources, these creative individuals have devised numerous thought-provoking alternative uses for the SAM Splint. They have been kind enough to share their innovations with us.

The following pages highlight some of our favorite alternative uses for the SAM Splint.

“In a survival situation the real value of a piece of equipment is not just that it accomplishes what it is designed to do but that it can also be used to solve many other problems faced by those in trouble. I have modified SAM Splints into everything from oil pipe covers to funnels, wind screens and even a frame for a wash basin. I don’t leave home without a SAM Splint in my emergency gear.”

Peter Kummerfeldt

Renowned Survival Expert/Trainer

Peter is a retired US Air Force veteran who trains Air Force Pilots in survival tactics and travels the continent lecturing on how to survive in extreme wilderness conditions.

HEAD BED

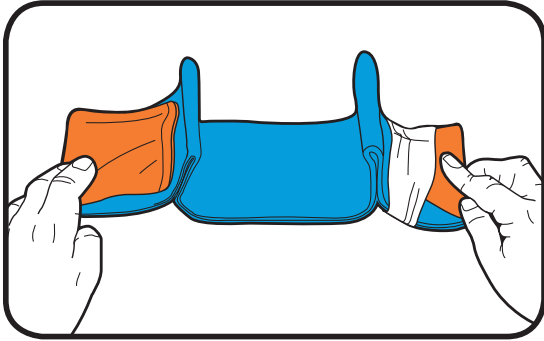

If a pre-formed Head Bed is not available, a SAM Splint can be used according to the illustration. The splint is placed flat beneath the head. It is then contoured to each side of the head. The remaining ends of the splint are folded in triangles which apply pressure to each side of the head. These triangles and the head itself are secured with tape.

FLAME GUARD

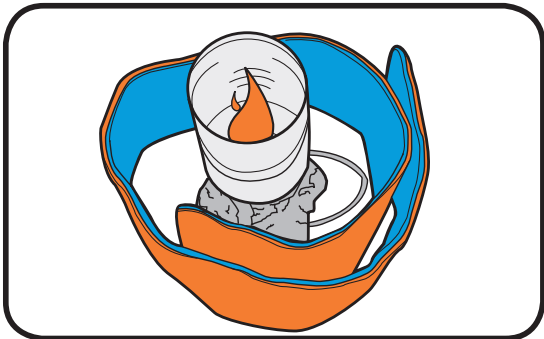

A 36-inch SAM Splint can be used as a flame guard for those situations when the flame in your camping stove keeps getting blown out by gusts of wind.

THOMAS HALF-RING SPLINT FOR FEMUR FRACTURES

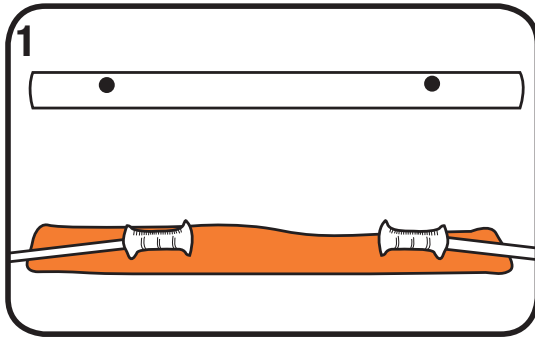

Step 1: First create the “foot support” by cutting an 8 inch section from an old ski pole. Drill 2 holes 6 inches apart through this foot support section. The hole should be sized with a larger entry hole and a smaller exit hole to tightly accommodate the tapered end of the ski pole. Keep the “foot support” section in your pack along with duct tape, safety pins, and strong cord (to be used for traction as desired). To create the “half-ring hip support”, place two ski poles, handle facing handle, each on the outer third of a 36-inch flat SAM Splint.

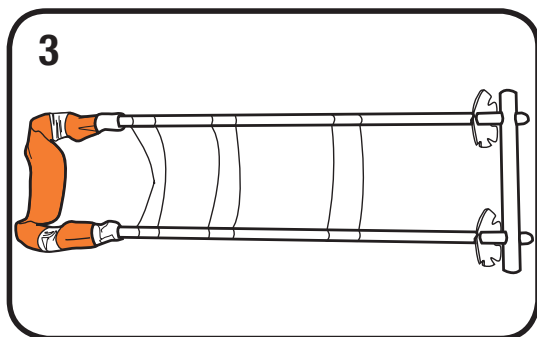
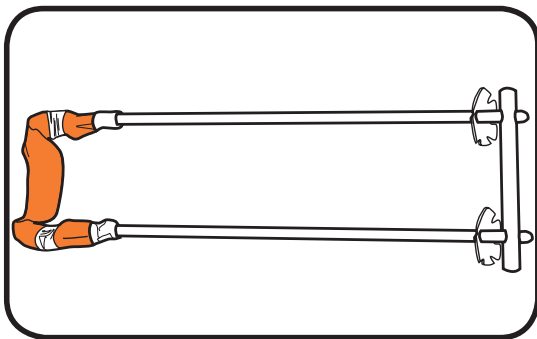
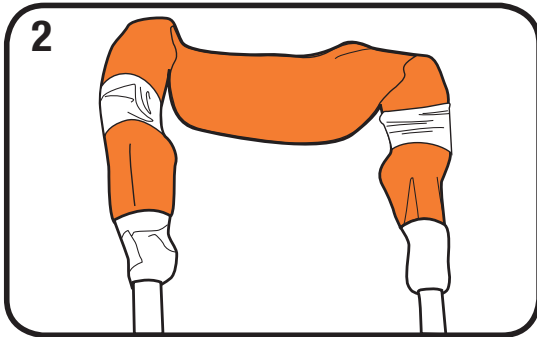

Step 2: Roll each end of the splint tightly around the handles and secure the splint with duct tape. The rolled middle third of the SAM Splint is then folded as the ski poles are aligned parallel to each other. The position of the ski poles is maintained by firmly fitting the tips of the poles into the tapered holes in the “foot support”. The rolled “hip support section” of the SAM Splint between the two ski poles handles is now contoured to resemble a Thomas half-ring.

Step 3: Duct tape thigh and calf supports are then applied and may be reinforced with cloth or elastic wraps.

FLASHLIGHT HOLDER

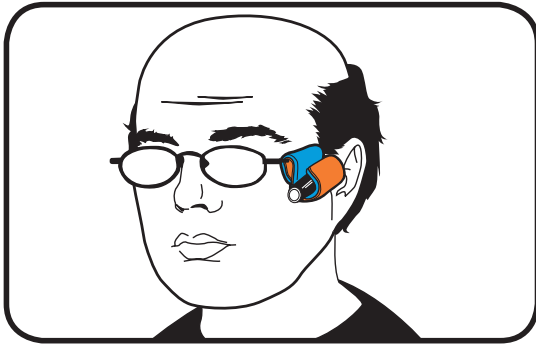

Cut a small strip of splint sufficiently long enough to wrap around the stem of your glasses and around your flashlight. This will allow you to use your light hands free. It is excellent for reading in bed.

CANOE PADDLE

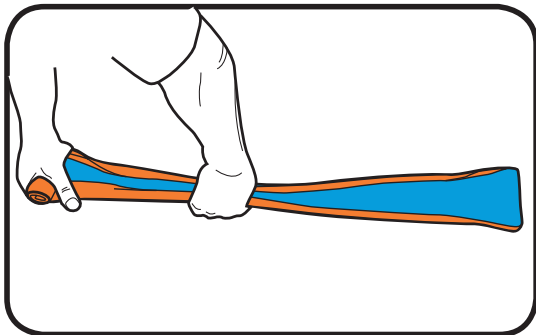

One end of the 36-inch splint is rolled to create a hand grip. The splint extending from that grip is folded to a corrugated cross-section as illustrated. This corrugation provides extreme strength for the paddle stem. The corrugation, although more relaxed, extends into the paddle blade itself. The handle and stem can be supported with duct tape.

SHORT SNOW SHOVEL

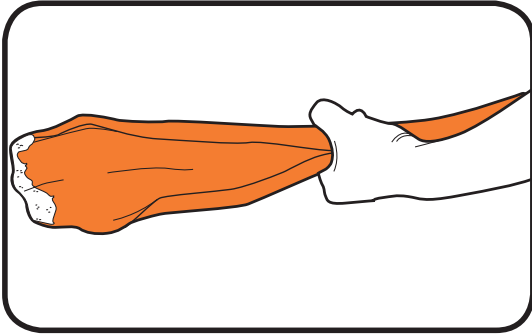

Same as the canoe paddle, except the EVA foam is cut or burned away from the shovel blade. The outer edges may be acutely folded for additional strength.

CLIMBING HELMET



A SAM Splint with duct tape can be used to construct a climbing helmet. This idea came from Elizabeth Owen, who created this helmet to protect a climbing accident victim.

CUP INSULATOR



1. Keeps soups hot.
2. Keeps beverages cold.

FLEXIBLE CONTAINER (SAM PAN)

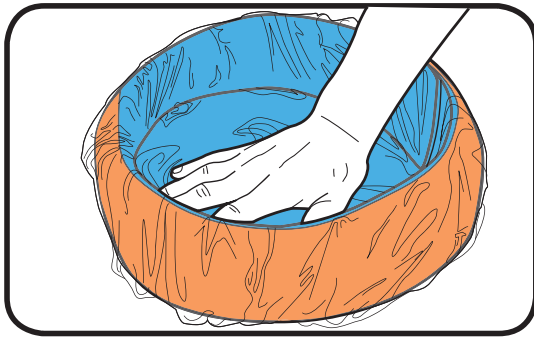

To create a SAM Pan, fold a 36-inch SAM Splint into a circle. The opposing ends of the splint may be left open or secured with interlocking bends, paper clips or duct tape. Select a standard plastic bag, sized to your desired use. Place the plastic bag within the splint circle and fold all excess bag over the splint edges. The folded portion of the bag can be left free, rolled over the splint or secured with paper clips.

You have now created a flexible basin suitable for many uses including:

1. The irrigation of scalp, trunk, and extremity wounds. With the ends of the splint left unfastened, the head and neck easily fit within the plastic bag.

The pan can be molded to any area, even between the legs.

2. For thawing frost bite in a wilderness setting.
3. For personal hygiene, one can use the SAM Pan as a wash basin, or for collecting body wastes (i.e. emesis basin, urinal or bed pan).
4. For use as a trash container.
5. In food preparation, or as a serving bowl.
6. For washing dishes.
7. For general packing or storing of items in suitcases, cupboards, etc.

My special thanks to Brian Horner, survival expert, who created the first SAM Pan on the slopes of Mount Denali, and successfully used it to thaw a frost-bitten foot.

EMERGENCY SANDALS

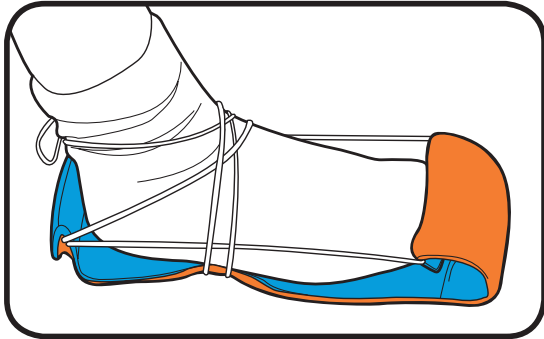

Another creation by Brian Horner. Fold the SAM Splint to fit the contours of your foot and use rope to secure the sandal in place.

IMPALED OBJECT PROTECTOR

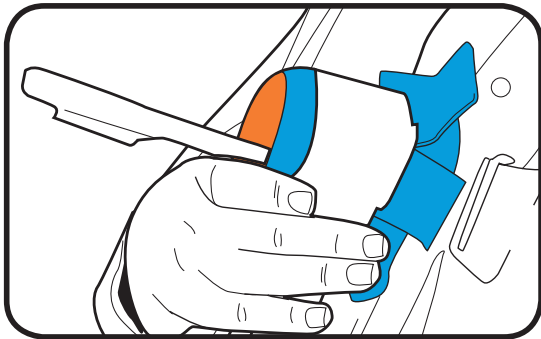

Cut a section of a SAM Splint to the desired length. Make a series of parallel cuts along one margin of the splint to create a number of flaps. Fold these flaps to 90 degrees so they lie at the right angle to the uncut margin of the splint. Roll the splint on itself and secure with tape. Place this device over the impaled object and secure to the body with tape or gauze.

SAM[®] VETERINARY SPLINT

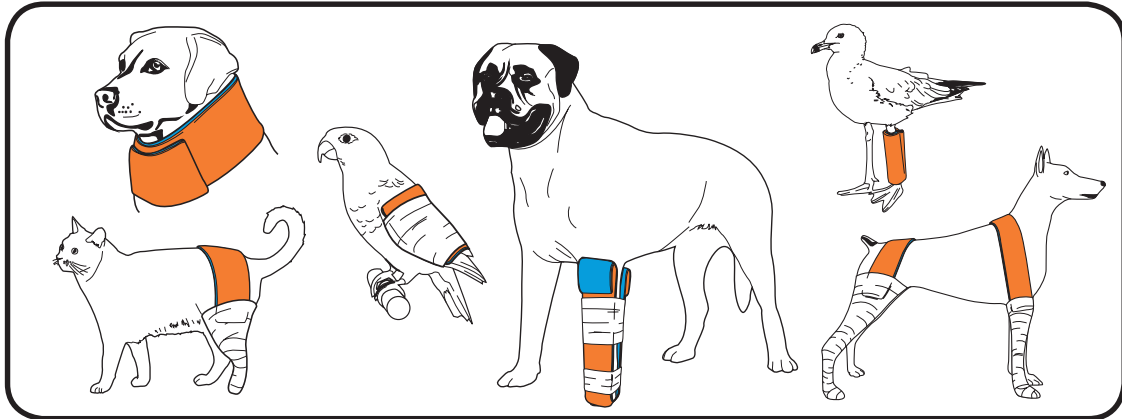

Use of the SAM[®] Splint in Veterinary Medicine

The SAM Splint, well accepted in the human field, has been carefully evaluated and improved to meet the unique requirements of veterinary medicine.

Applications

- Carpal and Tarsal Fractures
- Metacarpal and Metatarsal Fractures
- Post-surgical Support for IM Pinning or Plating of the Radius, Ulna, Tibia or Fibula
- Greenstick and Fissure Fractures
- Distal Tibia and Fibula Fractures in small dogs and cats
- Post-Reduction Luxated Tibial Tarsal Joint
- Emergency Immobilization of Humeral & Femoral Fractures while awaiting surgical treatment
- Post-Tendon Repair
- Chewing Restraints
- Post-Surgical Ear Crop Support Racks
- Avian Fractures

SAM SOFT SHELL® SPLINT



This combines the properties of a SAM Splint with soft, comfortable materials for long-wearing comfort. Easily removed and reshaped. No messy resins, plasters, rigid metal, or thermoplastics. Each SAM Soft Shell® Splint offers two levels of rigidity, thanks to differing thicknesses of aluminum at each end.

Please visit sammedical.com for complete product details.

SAM PELVIC SLING II™

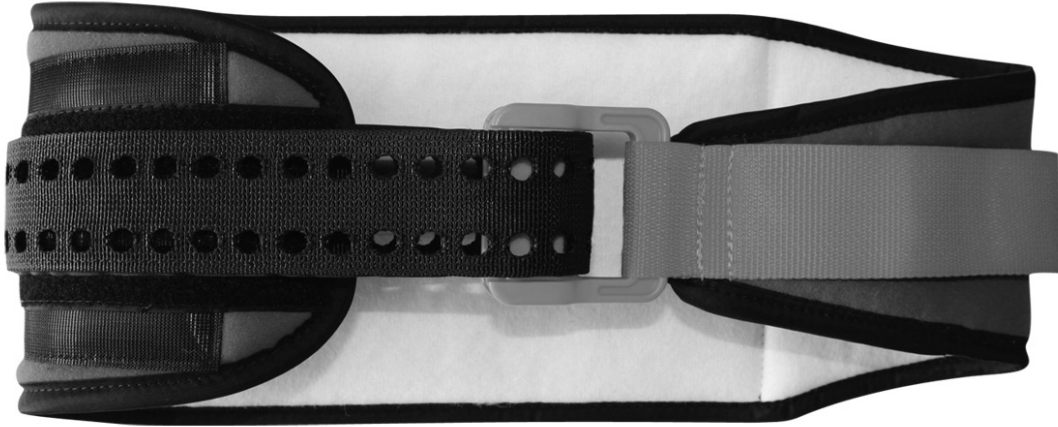

The SAM Pelvic Sling II™ (with its patented “auto-stop” buckle) is the world’s first and only force-controlled circumferential pelvic belt scientifically proven in peer-reviewed studies to provide safe and effective reduction and stabilization of open-book pelvic fractures.

BLIST-O-BAN®

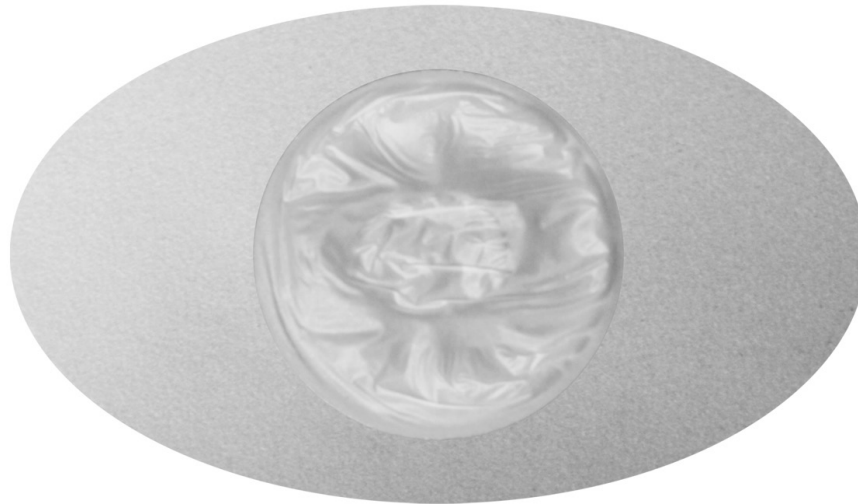

Blist-O-Ban is premium blister-prevention bandage ideal for all types of athletic use. Blist-O-Ban is a patented bandage with a built-in partially inflated dome that glides smoothly in all directions, dispersing friction and shear forces that cause blisters.

Please visit sammedical.com for complete product details.

SAM[®] CHEST SEAL

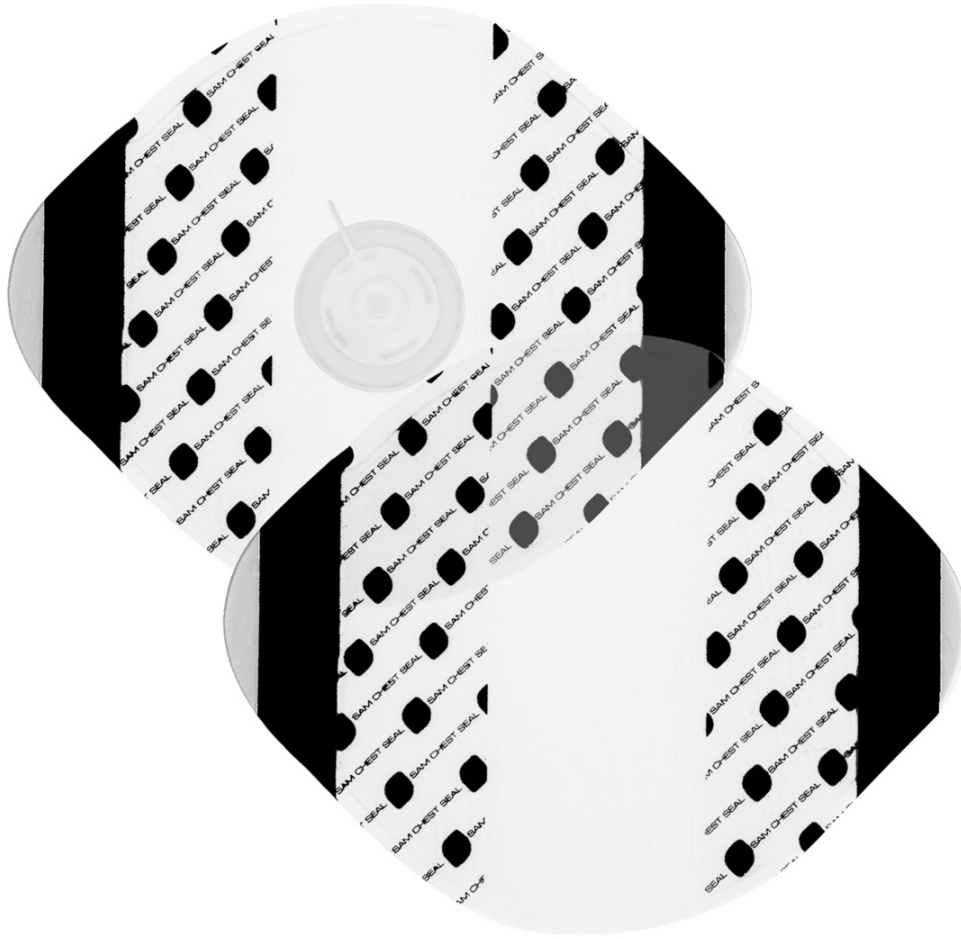

The SAM Chest Seal is an occlusive dressing designed for treating open chest wounds, a life-threatening situation that could lead to tension pneumothorax. The featured hydrogel adhesive also allows for the ability to reseal, making it ideal for venting.

The SAM Chest Seal is also available in a valve version. The one-way valve provides for low-resistance flow of air out of the chest cavity while preventing ingress.

Who uses the SAM Splint?

From outer space to the depths of the ocean, in all conditions of weather and terrain, the SAM Splint is the emergency splint of choice for: Military Medics, Athletic Trainers, First Responders, EMS, Wilderness Rescue, Ski Patrols, Outdoor Adventurers, Safety Engineers, Veterinarians, and more.

"For 20 years I have advised medical personnel on what medical gear to take on expeditions. These folks often ask me what I include in my kit, no matter where I'm traveling, no matter how short the trip. My answer; a few important medications, some tape, and always a SAM Splint. No other device allows for so many variations for treating an unimaginable variety of orthopedic emergencies."

Howard J. Donner, M.D.
Medical Operations Coordinator, NASA

"This splint is pure genius...light and compact, yet strong and resilient. I use it on every hike up to and back from Everest Base Camp. I won't leave home without it!"

Luanne Freer, M.D., FACEP
President, Wilderness Medical Society; Medical Director, Yellowstone National Park; Director, Everest Base Camp Medical Clinic

"The SAM Splint is a versatile tool that should be a part of every certified athletic trainer's field kit."

Ron Porterfield
Athletic Trainer, Tampa Bay Devil Rays

SAM MEDICAL
PRODUCTS®

PO BOX 3270 TUALATIN, OR 97062
INFO@SAMMEDICAL.COM | SAMMEDICAL.COM
800.818.4726 | 503.639.5474



MADE IN USA ISO 13485:2003 CERTIFIED

SPL-510-USE-1