

DeRom® Elbow

Single Patient Use Only

Rx Only

IMPORTANT

Read instructions before applying unit.

INTENDED USE

The DeRoyal® Range Of Motion (DeROM®) dynamic elbow orthosis was designed for the treatment of joint stiffness, and established soft tissue contractures, which may have resulted from trauma, immobilization, or neurological disorders. The orthosis should only be used under the supervision of a qualified health care professional. Protocols for use vary depending on the diagnosis and should be determined after consulting with the patient's physician. Combining flexion and extension in one unit, this orthosis can be used as a dynamic, static, or static-progressive splint.

CONTRAINDICATIONS

The DeROM® orthosis should not be used if any of the following conditions exist: Severe spasticity, severe osteoporosis, phlebitis or thrombophlebitis. Diabetes requires frequent skin checks. If pain, numbness, swelling, or skin irritation occurs while wearing the orthosis, it should be removed. The patient should be re-evaluated and appropriate adjustments made.

DIRECTIONS FOR USE

IMPORTANT: Set Tension Indicator Dial to 0. The Tension Indicator Dial (10) must be set to "0". Push the Tension Release Lever (6) in the direction of the arrow. At the same time turn the

Tension Indicator Dial to "0". All slack must be taken out of the cable before applying tension. After applying orthosis, push in on the black hinge knob (2) and rotate the pulley until the cable is taut.

1. To set up for extension

assist: The Tension Indicator Dial (10) must be set to "0". See "Important" above. Position the red cable (1) around the bottom of the pulley. Push in and hold the black hinge knob (2). At the same time push the forearm strut (3) to its lower most position. Release the black knob, and pull the forearm cuff to its upper most position. Repeat until the red cable is wrapped around the bottom of the pulley, and tension is felt on the cable.

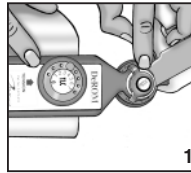

2. To set up for flexion

assist: The Tension Indicator Dial (10) must be set to "0". See "Important" above. Position the red cable (1) around the top of the pulley. Push in and hold the black hinge knob (2). At the same time pull the forearm strut (3) to its upper most position. Release the black knob, and push the forearm cuff to its lower most position. Repeat until the red cable is wrapped around the top of the pulley, and tension is felt on the cable.

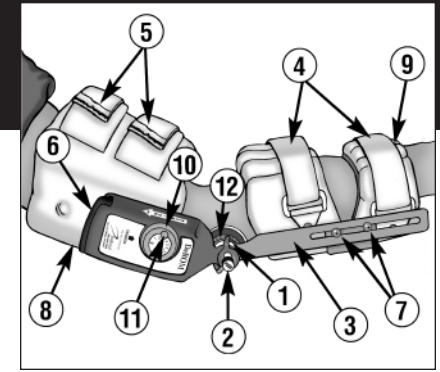
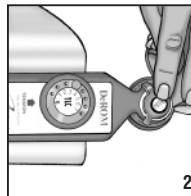

DeRom® Elbow

Single Patient Use Only

Rx Only

IMPORTANT

Read instructions before applying unit.

INTENDED USE

The DeRoyal® Range Of Motion (DeROM®) dynamic elbow orthosis was designed for the treatment of joint stiffness, and established soft tissue contractures, which may have resulted from trauma, immobilization, or neurological disorders. The orthosis should only be used under the supervision of a qualified health care professional. Protocols for use vary depending on the diagnosis and should be determined after consulting with the patient's physician. Combining flexion and extension in one unit, this orthosis can be used as a dynamic, static, or static-progressive splint.

CONTRAINDICATIONS

The DeROM® orthosis should not be used if any of the following conditions exist: Severe spasticity, severe osteoporosis, phlebitis or thrombophlebitis. Diabetes requires frequent skin checks. If pain, numbness, swelling, or skin irritation occurs while wearing the orthosis, it should be removed. The patient should be re-evaluated and appropriate adjustments made.

DIRECTIONS FOR USE

IMPORTANT: Set Tension Indicator Dial to 0. The Tension Indicator Dial (10) must be set to "0". Push the Tension Release Lever (6) in the direction of the arrow. At the same time turn the

Tension Indicator Dial to "0". All slack must be taken out of the cable before applying tension. After applying orthosis, push in on the black hinge knob (2) and rotate the pulley until the cable is taut.

1. To set up for extension

assist: The Tension Indicator Dial (10) must be set to "0". See "Important" above. Position the red cable (1) around the bottom of the pulley. Push in and hold the black hinge knob (2). At the same time push the forearm strut (3) to its lower most position. Release the black knob, and pull the forearm cuff to its upper most position. Repeat until the red cable is wrapped around the bottom of the pulley, and tension is felt on the cable.

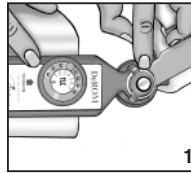

2. To set up for flexion

assist: The Tension Indicator Dial (10) must be set to "0". See "Important" above. Position the red cable (1) around the top of the pulley. Push in and hold the black hinge knob (2). At the same time pull the forearm strut (3) to its upper most position. Release the black knob, and push the forearm cuff to its lower most position. Repeat until the red cable is wrapped around the top of the pulley, and tension is felt on the cable.

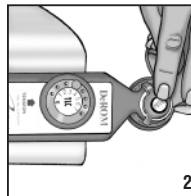

- 3. Donning the unit:** Position the arm in its end range. Unfasten forearm straps (4) and Biceps straps (5). Hold the arm in the neutral (thumb pointed up) position. Place orthosis on the arm with the mechanism on the lateral side (outside) of the arm, positioning the axis of the hinge centered at the elbow joint.

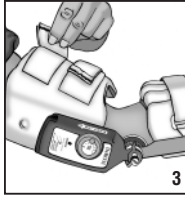

- 4. Adjust the forearm cuff length:** Remove the adjustment tool (6) from the rear of the plastic housing. Loosen the forearm cuff screws (7), and position the forearm cuff (9). Retighten the screws. Replace the adjustment tool by snapping it into the rear of the plastic housing.

- 5. Mold the Biceps Cuff:** Mold the Biceps cuff (8) around the Biceps, and cinch the two straps (5) for a snug, comfortable fit.

- 6. Mold the forearm cuff:** Mold the forearm cuff (9) around the forearm, and cinch the two straps (4) for a snug, comfortable fit.

- Note:** Set Tension Indicator Dial to "0" prior to taking slack out of the red cable. See "Important". All slack must be taken out of the cable before applying tension. Push in on the black hinge knob (2) and rotate the pulley until the cable is taut.

- 7. Applying tension:**

- Remove the adjustment tool (6) and insert it into one of the holes on the edge of the tension indicator dial (10). Rotate the dial in the direction of the arrow.

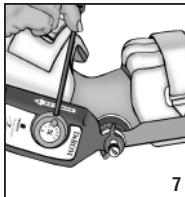

- Each "click" increases the tension. Adjust tension to patient tolerance. Replace the adjustment tool by snapping it into the rear of the plastic housing.

- 8. Releasing tension:** Push the Tension Release Lever (6), at the back end of the

plastic housing, in the direction the arrow indicates.

- 9. Tension Locking Control (TLC):** Once the appropriate tension level is determined, unscrew the TLC knob (11), and position it in the threaded hole nearest the tension indicator arrow, to prevent applying excessive tension. Screw the TLC knob completely in.

- 10. Setting ROM limiters:** Pull the ROM stops (12) outward, and out of the stop hole. Reposition to the desired position, and insert into the appropriate stop hole.

- 11. Removing orthosis:** Release tension per step #8. Open the two forearm straps (4), and the two Biceps straps (5) by pulling on the colored end of each strap.

CARE INSTRUCTIONS

Clean Wire-Foam™ pads and exterior of hinge with non-abrasive cleaner. Straps may be machine-washed. Air-dry orthosis and straps prior to wearing.

PRECAUTION

Caution should be used if any of these conditions exist: peripheral vascular disease, healing skin wounds, mild spasticity, heterotrophic ossification, and mild osteoporoses and diabetes.



Manufacturer
DeRoyal
200 DeBusk Lane, Powell, TN 37849 U.S.A.
888.938.7828
865.938.7828

Authorized Representative
DeRoyal Europe, Ltd.
Virginia Road, Kells, County Meath Ireland
353.46.9280100

©2006 DeRoyal. All Rights Reserved.
Part #1-4129 Revision 06
Revised 2/06

- 3. Donning the unit:** Position the arm in its end range. Unfasten forearm straps (4) and Biceps straps (5). Hold the arm in the neutral (thumb pointed up) position. Place orthosis on the arm with the mechanism on the lateral side (outside) of the arm, positioning the axis of the hinge centered at the elbow joint.

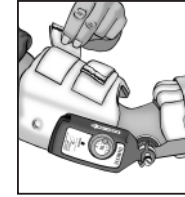

- 4. Adjust the forearm cuff length:** Remove the adjustment tool (6) from the rear of the plastic housing. Loosen the forearm cuff screws (7), and position the forearm cuff (9). Retighten the screws. Replace the adjustment tool by snapping it into the rear of the plastic housing.

- 5. Mold the Biceps Cuff:** Mold the Biceps cuff (8) around the Biceps, and cinch the two straps (5) for a snug, comfortable fit.

- 6. Mold the forearm cuff:** Mold the forearm cuff (9) around the forearm, and cinch the two straps (4) for a snug, comfortable fit.

- Note:** Set Tension Indicator Dial to "0" prior to taking slack out of the red cable. See "Important". All slack must be taken out of the cable before applying tension. Push in on the black hinge knob (2) and rotate the pulley until the cable is taut.

- 7. Applying tension:**

- Remove the adjustment tool (6) and insert it into one of the holes on the edge of the tension indicator dial (10). Rotate the dial in the direction of the arrow.

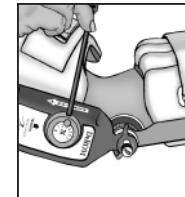

- Each "click" increases the tension. Adjust tension to patient tolerance. Replace the adjustment tool by snapping it into the rear of the plastic housing.

- 8. Releasing tension:** Push the Tension Release Lever (6), at the back end of the

plastic housing, in the direction the arrow indicates.

- 9. Tension Locking Control (TLC):** Once the appropriate tension level is determined, unscrew the TLC knob (11), and position it in the threaded hole nearest the tension indicator arrow, to prevent applying excessive tension. Screw the TLC knob completely in.

- 10. Setting ROM limiters:** Pull the ROM stops (12) outward, and out of the stop hole. Reposition to the desired position, and insert into the appropriate stop hole.

- 11. Removing orthosis:** Release tension per step #8. Open the two forearm straps (4), and the two Biceps straps (5) by pulling on the colored end of each strap.

CARE INSTRUCTIONS

Clean Wire-Foam™ pads and exterior of hinge with non-abrasive cleaner. Straps may be machine-washed. Air-dry orthosis and straps prior to wearing.

PRECAUTION

Caution should be used if any of these conditions exist: peripheral vascular disease, healing skin wounds, mild spasticity, heterotrophic ossification, and mild osteoporoses and diabetes.



Manufacturer
DeRoyal
200 DeBusk Lane, Powell, TN 37849 U.S.A.
888.938.7828
865.938.7828

Authorized Representative
DeRoyal Europe, Ltd.
Virginia Road, Kells, County Meath Ireland
353.46.9280100

©2006 DeRoyal. All Rights Reserved.
Part #1-4129 Revision 06
Revised 2/06